



12 FLUIDIC CONNECTIONS

114 VALVES

150 DEGASSERS

156 COLUMN HARDWARE

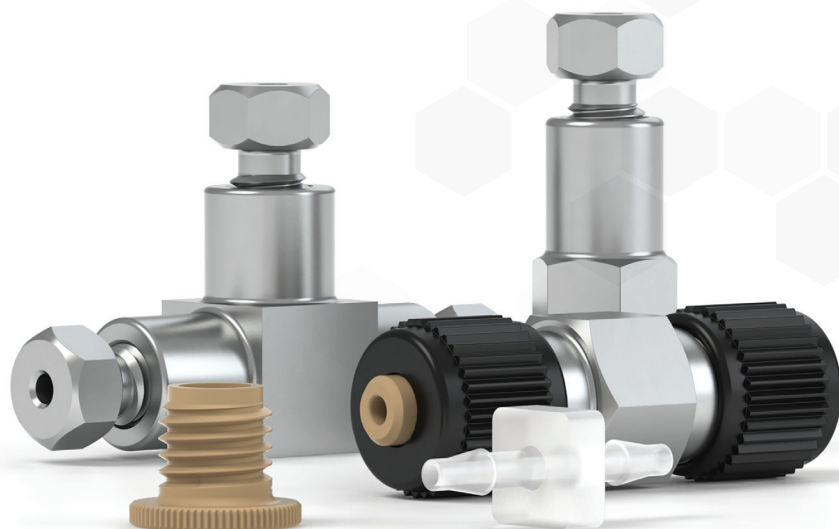

CONNECTORS

Connectors are designed to securely join tubing together or to facilitate the joining of tubing to other fluid pathway components. We offer multiport connectors with different thread and port configurations to meet your system requirements and connection needs. Some of our connectors feature a True ZDV (Zero Dead Volume) internal configuration that helps minimize the formation of dead volume in your fluidic pathway. Our versatile adapters help bring two connectors with different configurations together. Connectors are manufactured from 316 stainless steel or from inert polymers to ensure chemical compatibility with the fluid passing through. Peristaltic tube connectors are ideal for making connections with soft-walled, peristaltic tubing. Our extensive line of connectors includes tees, crosses, Luer Adapters, barbed and threaded adapters, and a variety of other options.

- | | | | |
|-----------|--|-----------|---|
| 63 | THREADED ADAPTERS | 79 | ACCESSORIES |
| 67 | HIGH PRESSURE
MULTIPORT
CONNECTORS | 80 | NANOPORT
ASSEMBLIES |
| 72 | ULTRA HIGH
PRESSURE MULTIPORT
CONNECTORS | 81 | LOW PRESSURE
MULTIPORT
CONNECTORS |
| 77 | MICROTIGHT®
ADAPTERS | 90 | LUER ADAPTERS |
| | | 91 | PERISTALTIC TUBE
CONNECTORS |



Threaded Adapters

- › Threaded adapters in a variety of configurations
- › English, Metric, and NPT threaded adapters offered
- › Bring together connectors with different threads
- › Manufactured from inert polymers — PEEK, PCTFE, ETFE, and PTFE

Two of the many challenges researchers face regularly, are trying to use one style of fitting for all connections, or trying to join two different sizes of tubing. To assist in overcoming these challenges we have engineered one of the most extensive threaded adapter lines available.

Threaded Adapters come in a wide variety of configurations to meet your system requirements. They are designed to effectively bring together connectors with different threads. We offer them in English, Metric, and NPT versions. Manufactured from inert polymers and stainless steel they deliver excellent chemical resistance.



English Threaded Adapters

Our versatile English Threaded Adapters are used specifically to securely attach connectors with different threads. We designed these adapters to work with English to English threaded geometries. Manufactured from Stainless Steel, PEEK, or Tefzel™ (ETFE), they deliver excellent solvent resistance.

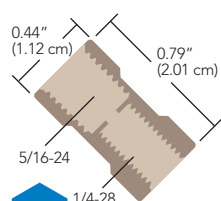

P-135
0.080" (2.05 mm) thru-hole

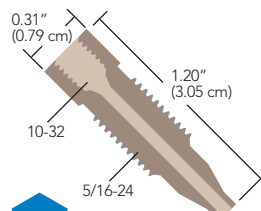

6000-076
0.066" (1.70 mm) thru-hole

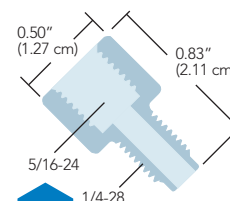

P-681
0.125" (3.20 mm) thru-hole

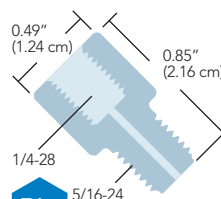

P-718
0.040" (1.00 mm) thru-hole

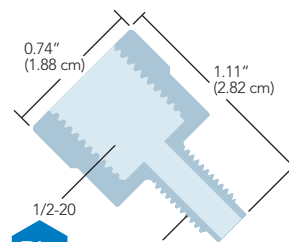

P-684
0.130" (3.30 mm) thru-hole



P-627
0.020" (0.50 mm) thru-hole
Includes (1) F-300 for 1/16" OD tubing

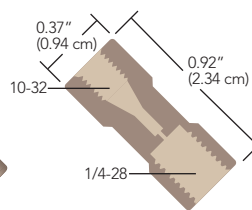

Threaded Adapters (Cont.)

NOTE

- When using an adapter with male (external) threads, we recommend you first attach the adapter body into the receiving port, and then connect your tubing and fitting into the head of the adapter body.

RELATED PRODUCTS

- Use the 6000-076 Adapter to connect 1/16" OD tubing to the Preparative-Scale Injector Valve (page 66).
- You may not need an adapter to connect 1/16" OD tubing into your flat-bottom port. A less expensive alternative is to use a Flangeless Nut and Ferrule starting on page 45 or a Super Flangeless™ Nut and Ferrule starting on page 39.

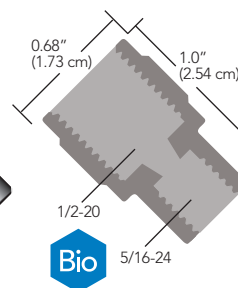
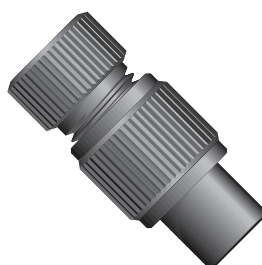

Bio

U-659

Tapered thru-hole
Includes (1) U-650/U-655
for 1/4" OD tubing

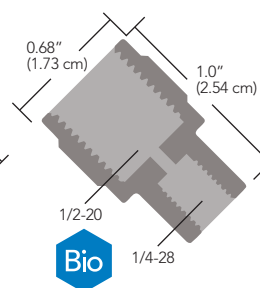

Bio

U-665

0.063" (1.60 mm) thru-hole
Includes (1) U-650/U-655
for 1/4" OD tubing



Bio

P-652

0.030" (0.75 mm) thru-hole
(Note the new knurled design)

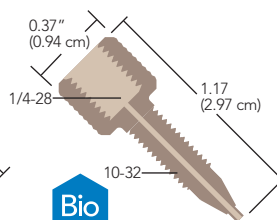
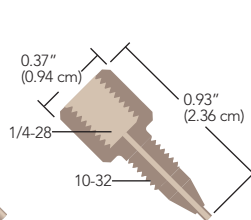

Bio

P-654

Extra Long, 0.030"
(0.76 mm) thru-hole

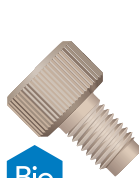

Bio

P-669-01

0.040" (1.00 mm) thru-hole

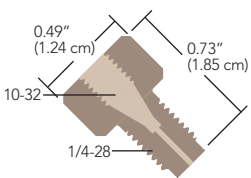

Bio

P-671

0.040" (1.00 mm) thru-hole

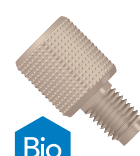
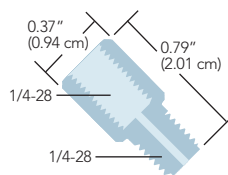

Bio

P-672

0.050" (1.25 mm) thru-hole

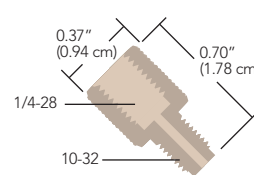

APPLICATION NOTE

Here are application ideas using two of our popular adapters:

- Many injection valves used in HPLC systems have 10-32 coned ports designed to accept 1/16" OD tubing. However, this may be a problem if large injection volumes are required (in excess of 10 mL). The most popular loops for large volume samples are made from 1/8" OD tubing, making it impossible to connect these larger volume loops to your injection valve. The solution: use our P-654 Adapter and the appropriate fittings for your sample loop. This set-up allows connection of 1/8" OD sample loop leads to your injection valve.
- Another potential application is connecting tubing to low-pressure solenoid valves with 1/4-28 flat-bottom ports. Most low-pressure valves of this type have very shallow threaded ports, which typically preclude the use of our Flangeless Fittings. However, by first threading our P-671 Adapter into the valve port(s), you can effectively use standard 1/4-28 fittings to connect your tubing into the backside of the adapter body. This also saves "wear and tear" on the threads in the valve ports.



Metric Threaded Adapters

Our versatile Metric Threaded Adapters are used specifically to effectively attach connectors with different threads. We designed these adapters to work with English to Metric threaded geometries. Manufactured from Stainless Steel, PEEK or Tefzel™ (ETFE) they deliver excellent solvent resistance.

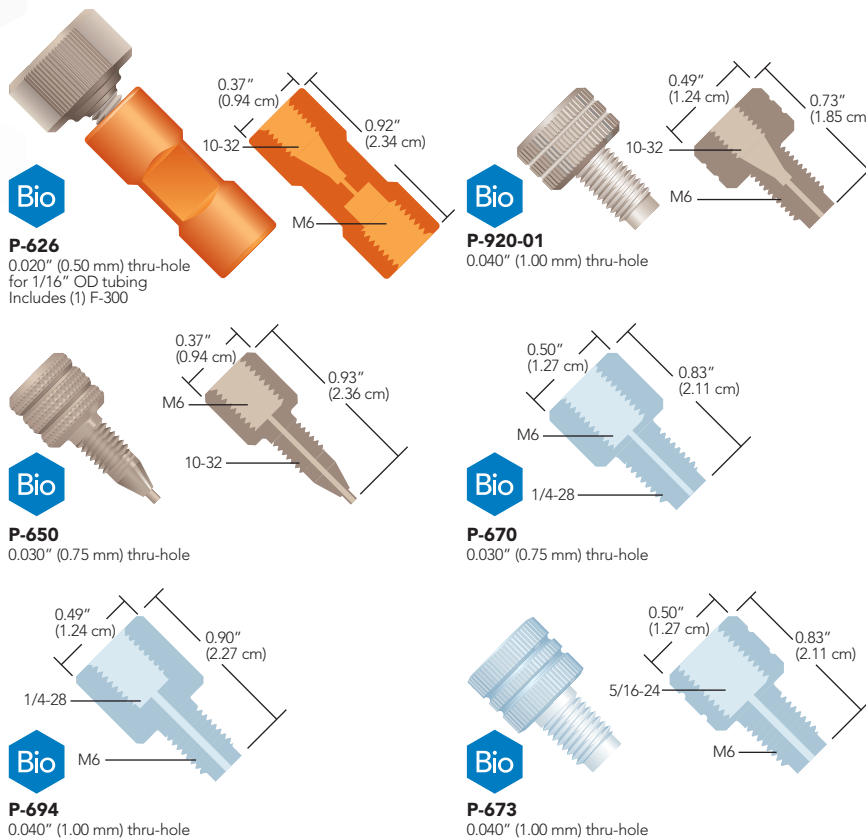

RELATED PRODUCTS

- › For an alternative to the Female M6 Adapters presented above, try a P-602 or P-622 Low Pressure Metric Union from page 84, along with the appropriate Metric Flangeless Fittings on page 43.
- › To direct connect your tubing into a flat-bottom port, find the appropriate Flangeless or Super Flangeless™ Fittings on page 45 and page 39 respectively.
- › Need metric fittings for your connections? See page 43.

Threaded Adapters (Cont.)



National Pipe Thread Adapters

These adapters make connections to female 1/8" and 1/4" National Pipe Thread (NPT) ports.

Manufactured from PEEK polymer, our NPT Adapters are durable and chemically resistant. We provide versions with either 1/4-28 or 5/16-24 flat-bottom threads, suitable for most low pressure applications.

Please Note: Wrap the threads on the NPT side of these adapters with thread seal tape (plumber's tape) to ensure a leak-free seal.

RELATED PRODUCTS

Replacement fittings for these adapters are located on the pages indicated below:

	Page(s)
1/4-28 for 1/8" OD tubing	41
5/16-24 for 1/8" OD tubing	41, 56
5/16-24 for 3/16" OD tubing	41

Other tubing/fitting combinations are available. For more information, please contact your local Distributor or IDEX Health & Science directly.

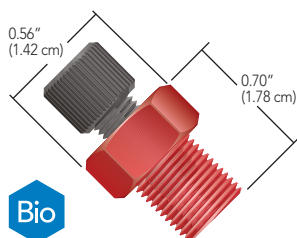

U-510
1/8" NPT to 1/4-28 Flat-Bottom Female Adapter for 1/8" OD tubing Includes (1) XP-308 Fitting

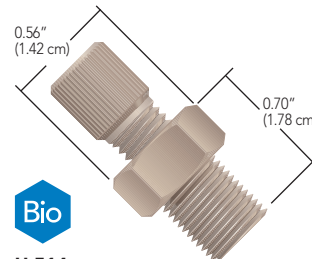

U-514
1/8" NPT to 5/16-24 Flat-Bottom Female Adapter for 3/16" OD tubing Includes (1) XP-132 Fitting

APPLICATION NOTE

Our U-500 and U-510 NPT Adapters are great for attaching 1/8" OD fluoropolymer sparging lines to sparging gas tank regulating valves. Simply thread the appropriately-sized NPT Adapter into the valve's receiving port and then attach your sparging tubing to the adapter body using the fittings provided.

Threaded Adapters

Part No.	Description	Includes	Thru-hole	Swept Volume	Pressure Rating	Qty.		
ENGLISH THREADED ADAPTERS								
6000-076	PEEK Adapter, 5/16-24 C, M to 10-32 C, F	N/A	0.066" (1.70 mm)	49.8 µL	3,000 psi (207 bar)	ea.		
P-135	PEEK Adapter, 5/16-24 FB, F to 1/4-28 F	N/A	0.080" (2.05 mm)	4.1 µL	1,000 psi (69 bar)	ea.		
P-627	PEEK Adapter, 10-32 C, F to 1/4-28 FB, F	(1) F-300	0.020" (0.50 mm)	0.30 µL	1,000 psi (69 bar)	ea.		
P-681	PCTFE Adapter, 5/16-24 FB, F to 1/4-28 FB, M	N/A	0.125" (3.20 mm)	96.6 µL	1,000 psi (69 bar)	ea.		
P-684	PCTFE Adapter, 1/2-20 FB, F to 1/4-28 FB, M	N/A	0.130" (3.30 mm)	121.7 µL	250 psi (17 bar)	ea.		
P-718	PCTFE Adapter, 5/16-24 FB, M to 1/4-28 FB, F	N/A	0.040" (1.00 mm)	10.3 µL	1,000 psi (69 bar)	ea.		
U-659	PEEK Adapter, 5/16-24 FB, F to 1/2-20 FB, F	(1) XU-655	Tapered**	42.0 µL	250 psi (17 bar)	ea.		
U-665	PEEK Adapter, 1/2-20 FB, F to 1/4-28 FB, F	(1) XU-655	0.063" (1.60 mm)	6.6 µL	250 psi (17 bar)	ea.		
P-652	PEEK Adapter, 1/4-28 FB, F to 10-32 C, M	N/A	0.030" (0.75 mm)	6.7 µL	1,000 psi (69 bar)	ea.		
P-654	PEEK Adapter, 1/4-28 FB, F to 10-32 C, M, Extra Long	N/A	0.030" (0.75 mm)	9.5 µL	1,000 psi (69 bar)	ea.		
P-669-01	PEEK Adapter, 10-32 C, F to 1/4-28 FB, M	N/A	0.040" (1.00 mm)	6.6 µL	1,000 psi (69 bar)	ea.		
P-671	PTFE Adapter, 1/4-28 FB, F to 1/4-28 FB, M	N/A	0.040" (1.00 mm)	8.0 µL	1,000 psi (69 bar)	ea.		
P-672	PEEK Adapter, 1/4-28 FB, F to 10-32 FB, M	N/A	0.050" (1.25 mm)	11.4 µL	1,000 psi (69 bar)	ea.		
METRIC M6 THREADED ADAPTERS								
P-626	PEEK Adapter, 10-32 C, F to M6 FB, F	(1) F-300	0.020" (0.50 mm)	0.3 µL	1,000 psi (69 bar)	ea.		
P-650	PEEK Adapter, M6 FB, F to 10-32 C, M Standard	N/A	0.030" (0.75 mm)	6.7 µL	1,000 psi (69 bar)	ea.		
P-670	PCTFE Adapter, M6 FB, F to 1/4-28 FB, M	N/A	0.030" (0.75 mm)	2.6 µL	1,000 psi (69 bar)	ea.		
P-673	PCTFE Adapter, 5/16-24 FB, F to M6 FB, M	N/A	0.040" (1.00 mm)	9.9 µL	1,000 psi (69 bar)	ea.		
P-694	PCTFE Adapter, 1/4-28 FB, F to M6 FB, M	N/A	0.040" (1.00 mm)	11.3 µL	1,000 psi (69 bar)	ea.		
P-920-01	PEEK Adapter, 10-32 C, F to M6 FB, M	N/A	0.040" (1.00 mm)	8.0 µL	1,000 psi (69 bar)	ea.		
1/8" MALE NATIONAL PIPE THREAD ADAPTERS								
Part No.	Description	Color	Tubing OD	Includes	Thru-hole	Swept Volume	Pressure Rating	Qty.
U-510	PEEK 1/8" NPT, M to 1/4-28 FB, F Adapter	Red	1/8"	(1) XP-308	0.062" (1.60 mm)	17.3 µL	500 psi (34 bar)	ea.
U-514	PEEK 1/8" NPT, M to 5/16-24 FB, F Adapter	Natural	3/16"	(1) XP-132	0.125" (3.2 mm)	70.4 µL	500 psi (34 bar)	ea.
1/4" MALE NATIONAL PIPE THREAD ADAPTERS								
U-500	PEEK 1/4" NPT, M to 1/4-28 FB, F Adapter	Red	1/8"	(1) XP-308	0.062" (1.60 mm)	17.3 µL	500 psi (34 bar)	ea.
U-504	PEEK 1/4" NPT, M to 5/16-24 FB, F Adapter	Natural	3/16"	(1) XP-132	0.125" (3.2 mm)	70.4 µL	500 psi (34 bar)	ea.

F = Female (internal) threads; M = Male (external) threads; XL = extra long; C = Coned; FB = Flat-Bottom

* The pressure rating of this adapter exceeds the pressure holding ability of the fittings and tubing used with it.

** Thru-hole tapers from 0.188" (4.80 mm) to 0.125" (3.20 mm).



High Pressure Mixing Tees

Mixing Tees utilize a specifically engineered internal geometry to efficiently mix two fluid streams into one combined stream. Mixing Tees are ideal for microbore or analytical gradient HPLC. These mixing tees are specifically designed for high pressure applications.

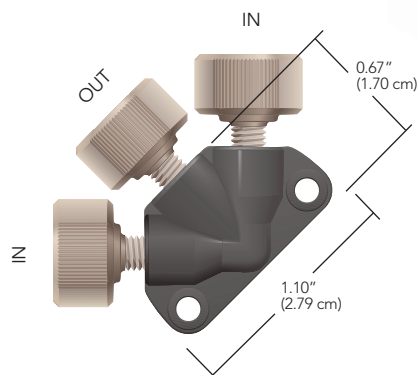

U-466 and U-466S
Static Mixing Tees with F-300 Fingertight Fittings for 1/16" OD tubing

Static Mixing Tees

- › PEEK body with two-piece fingertight fittings
- › Low swept volume

Static Mixing Tees are ideal for microbore or analytical gradient HPLC. They have a low swept volume of 2.2 μL (includes frit volume) and are designed for flow rates of 0.5 to 3 mL/min and a maximum pressure of 5,000 psi (345 bar). The back pressure caused by the tee is typically only 10 to 20 psi (0.7 to 1.4 bar) at these flow rates. The thru-holes are 0.020" (0.50 mm) and the center port features a 10 μm UHMWPE or stainless steel frit that aids mixing.



NOTE

- › Turbulent mixing of solvents often increases outgassing. To maintain a bubble-free fluid pathway, we recommend solvent degassing when using this product.
- › The frit incorporated into our U-466 and U-466S Static Mixing Tees is not replaceable. If it becomes clogged, the Mixing Tee must be replaced.

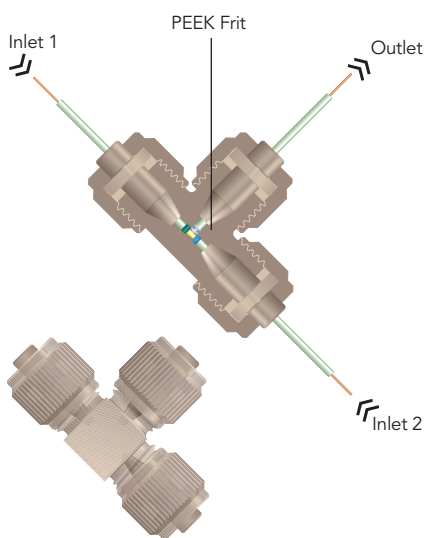

M-540
Micro Static Mixing Tee 0.010" thru-hole with fittings included (tubing and tubing sleeves not included)

Micro Static Mixing Tee

- › Constructed of inert PEEK and PCTFE
- › Low swept volume of 0.95 μL
- › Designed for flow rates of 20–250 $\mu\text{L}/\text{min}$

Our Micro Static Mixing Tee utilizes a specifically engineered internal geometry to efficiently mix two fluid streams into one combined stream. The center port also features a 0.5 μm porosity PEEK polymer frit to aid in mixing. This frit adds a maximum of 20 psi (1.4 bar) back pressure to most systems (within the stated flow rate range). The Mixing Tee handles a maximum pressure of 5,000 psi (345 bar) when directly connecting 1/16" OD tubing, or up to 4,000 psi (276 bar) with capillary tubing when using our NanoTight™ Fittings and Tubing Sleeves (page 37).



RELATED PRODUCTS

- › See our Vacuum Degassing Systems on page 154.
- › Our standard Static Mixing Tees are designed for flow rates from 0.5 mL/min to 3 mL/min.

High Pressure Mixing Tees (Cont.)



APPLICATION NOTE

Several researchers use our PEEK MicroTee to introduce ionizing voltage to their fluid stream just prior to a Mass Spectrometer¹. MicroTees are well suited for this application due to advantageous internal geometry and PEEK polymer's electrical resistance. The materials required for this setup are as follows: one gold or platinum conducting wire, one P-775 or P-875 MicroTee (this page), one MicroTight Tubing Sleeve (page 52) for the conducting wire (as needed to accommodate wire diameter), and at least two more MicroTight Tubing Sleeves (page 52) to connect your capillary tubing.

To set up a similar connection, first thread your wire through the appropriate tubing sleeve, if necessary, with the wire extending beyond both ends of the sleeve. Slip the female nut included with the MicroTee over the wire or sleeved wire, followed by the ferrule — ensuring the wire (and its sleeve) extends well past the end of the ferrule tip. Align the tip of the wire with the thru-hole of the MicroTee and gently insert the wire until it bottoms out. Now finger tighten the female nut into place. Attach your flow path tubing to the MicroTee's two other available ports, following the instructions provided with the MicroTee.

Begin fluid flow through the tee and apply voltage to the conducting wire lead. This setup typically provides effective electrospray ionization in applications having a flow rate of 100 µL/min or greater.

¹ One such paper describing pioneering electrospray work: *Protein Identification at the Low Femtomole Level from Silver-Stained Gels Using a New Fritless Electrospray Interface for Liquid Chromatography-Microspray and Nanospray Mass Spectrometry*. Christine L. Gatlin, Gerd R. Kleemann, Lara G. Hays, Andrew J. Link, John R. Yates III (1998) *Analytical Biochemistry* 263, 93-101.

MicroTee & Cross for Capillary Tubing

- › Direct connect 1/16", 1/32", 360 µm OD tubing, plus other capillary tubing
- › Low swept volume

Use our MicroTees and MicroCrosses to join capillary tubing. All of these products are made entirely of PEEK and have 0.006" (0.150 mm) thru-holes, with resulting swept volumes ranging from 29 to 81 nL.



NOTE

- › Use only the ferrules supplied with each connector — they are not interchangeable. Replacement ferrules and female nuts are available on page 35. For MicroUnions, MicroTees, and MicroCrosses for UHPLC applications, see page 72.

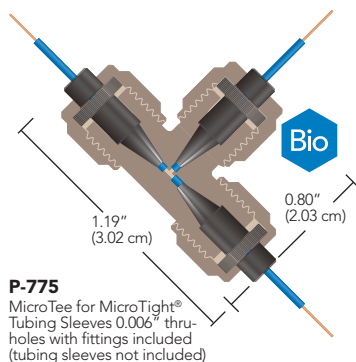

P-775
MicroTee for MicroTight® Tubing Sleeves 0.006" thru-holes with fittings included (tubing sleeves not included)

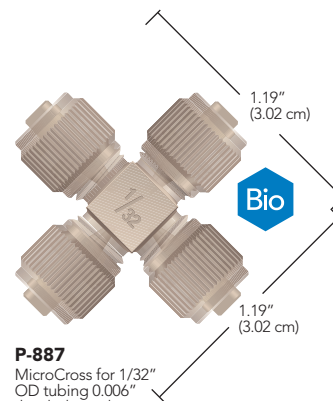

P-887
MicroCross for 1/32" OD tubing 0.006" thru-holes with fittings included

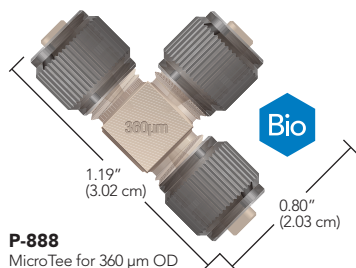

P-888
MicroTee for 360 µm OD tubing 0.006" thru-holes with fittings included

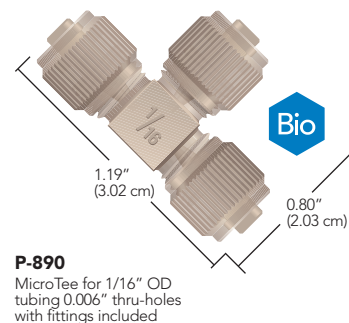

P-890
MicroTee for 1/16" OD tubing 0.006" thru-holes with fittings included

High Pressure Mixing Tees

Part No.	Description	Threads	Includes	Thru-hole	Swept Volume	Pressure Rating	Qty.
STATIC MIXING TEE							
U-466	PEEK Static Mixing Tee for 1/16" OD Tubing, 10 µm UHMWPE Frit	10-32 Coned	(3) F-300	0.020" (0.50 mm)	2.2 µL	5,000 psi (345 bar)	ea.
U-466S	PEEK Static Mixing Tee for 1/16" OD Tubing, 10 µm SST Frit	10-32 Coned	(3) F-300	0.020" (0.50 mm)	2.2 µL	5,000 psi (345 bar)	ea.
MICRO STATIC MIXING TEE							
M-540	PEEK Micro Static Mixing Tee, for 1/16" OD Tubing	5/16-24 Coned	(3) F-132/P-416	0.010" (0.250 mm)	0.95 µL	5,000 psi (345 bar)	ea.
MICROTEE, MICROCROSS AND MICROELBOW							
P-775	PEEK MicroTee for MicroTight Sleeves	5/16-24 Coned	(3) F-172, (3) P-416	0.006" (0.150 mm)	29 nL	4,000 psi (276 bar)	ea.
P-777	PEEK MicroCross for MicroTight Sleeves	5/16-24 Coned	(4) F-172, (4) P-416	0.006" (0.150 mm)	38 nL	4,000 psi (276 bar)	ea.
P-875	PEEK MicroTee with Mounting Hole, for MicroTight Sleeves	5/16-24 Coned	(3) F-172, (3) P-416	0.006" (0.150 mm)	29 nL	4,000 psi (276 bar)	ea.
P-885	PEEK MicroTee for 1/32" OD Tubing	5/16-24 Coned	(3) F-112, (3) P-416	0.006" (0.150 mm)	29 nL	5,000 psi (345 bar)	ea.
P-887	PEEK MicroCross for 1/32" OD Tubing	5/16-24 Coned	(4) F-112, (4) P-416	0.006" (0.150 mm)	38 nL	5,000 psi (345 bar)	ea.
P-888	PEEK MicroTee for 360 µm OD Tubing	5/16-24 Coned	(3) F-152, (3) P-416BLK	0.006" (0.150 mm)	29 nL	5,000 psi (345 bar)	ea.
P-889	PEEK MicroCross for 360 µm OD Tubing	5/16-24 Coned	(4) F-152, (4) P-416BLK	0.006" (0.150 mm)	38 nL	5,000 psi (345 bar)	ea.
P-890	PEEK MicroTee for 1/16" OD Tubing	5/16-24 Coned	(3) F-132, (3) P-416	0.006" (0.150 mm)	58 nL	5,000 psi (345 bar)	ea.
P-891	PEEK MicroCross for 1/16" OD Tubing	5/16-24 Coned	(4) F-132, (4) P-416	0.006" (0.150 mm)	81 nL	5,000 psi (345 bar)	ea.



High Pressure Unions

PEEK ZDV Unions

Our PEEK zero-dead-volume (ZDV) Unions come complete with two F-300 Fingertight Fittings for 1/16" OD tubing and are pressure rated to 5,000 psi (344 bar).

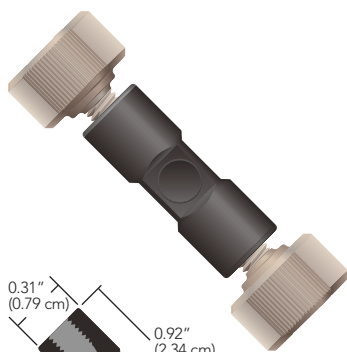

P-742
PEEK ZDV Union
0.010" thru-hole with
F-300 Fittings

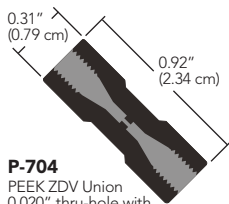

P-704
PEEK ZDV Union
0.020" thru-hole with
F-300 Fittings

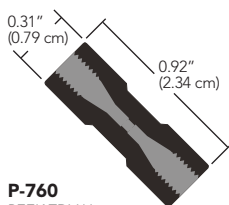

P-760
PEEK ZDV Union
0.050" thru-hole with
F-300 Fittings

Bio-Inert UHPLC Unions

- › Unique, Patent-Pending Process allows a fully-PEEK fluid contact area combined with the strength of stainless steel
- › Pressure rated to 17,400 psi (1,200 bar)
- › Two inner diameters available: 0.008" and 0.016"

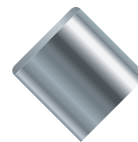

These unions are specifically engineered for Bio-Inert UHPLC applications. Combining the physical strength of 316 stainless steel with the inertness and biocompatibility of an all-PEEK fluid pathway, these unions will work well in applications where pressures reach up to 17,400 psi (1,200 bar) — without allowing metal contact by the fluid.

Neither union comes with fittings, but can be paired successfully with any 10-32 coned fitting that uses a polymer nose or ferrule.

Note: All-stainless steel fittings should NOT be used with these unions, as they will damage the internal conical seat.

NanoTight™ Union

NanoTight Unions improve capillary tubing connections in several ways. The internal design of the union greatly reduces the incidence of tubing misalignment. When using 1/16" OD tubing sleeves (found on page 52) to connect capillary tubing, the webbed thru-hole minimizes breaking of fused silica while adding only miniscule swept volume. The results are fewer blockages, fewer flow rate reductions and fewer back pressure problems.

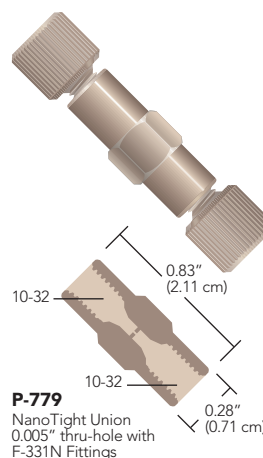

P-779
NanoTight Union
0.005" thru-hole with
F-331N Fittings

Part No.	Description	Threads	Includes	Thru-hole	Swept Volume	Pressure Rating	Qty.
BIO-INERT UHPLC UNIONS							
UP-700 Obsolete	Bio-Inert UHPLC Union for 1/16" OD Tubing, Natural (Tan)	10-32 Coned	N/A	0.008" (0.20 mm)	0.05 µL	17,400 psi (1,200 bar)	ea.
PEEK ZDV UNIONS							
P-704	PEEK Union for 1/16" OD Tubing	10-32 Coned	(2) F-300	0.020" (0.50 mm)	0.28 µL	5,000 psi (344 bar)	ea.
P-742	PEEK Union for 1/16" OD Tubing	10-32 Coned	(2) F-300	0.010" (0.25 mm)	0.07 µL	5,000 psi (344 bar)	ea.
P-760	PEEK Union for 1/16" OD Tubing	10-32 Coned	(2) F-300	0.050" (1.25 mm)	1.2 µL	5,000 psi (344 bar)	ea.
NANOTIGHT UNION							
P-779	PEEK NanoTight Union for 1/16" OD Tubing and Tubing Sleeves	10-32 Coned	(2) F-331N	0.005" (125 µm)	8 nL	5,000 psi (344 bar)	ea.

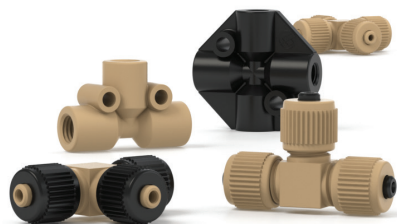

High Pressure PEEK Tees & Crosses

- › Highest pressure holding flat-bottom fitting system we offer
- › Eliminates loosening of fittings due to tubing twist
- › Excellent for Tubing Assemblies
- › Holds tight even through vibration

Our PEEK Tees and Crosses include high pressure F-300 PEEK Fingertight Fittings — allowing maximum operating pressures to 3,500 psi (241 bar) when used with 1/16" OD PEEK or stainless steel tubing.

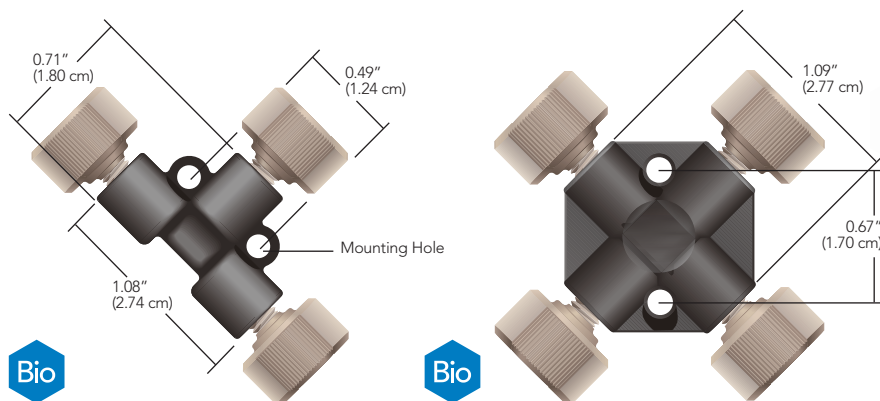

P-727 PEEK Tee
0.020" thru-hole with F-300 Fittings

P-729 PEEK Cross
0.020" thru-hole with F-300 Fittings

PEEK 7-Port Manifold

Combine several streams into one or split one fluid stream into several. This PEEK 7-Port Manifold comes complete with F-331 Fingertight Fittings for 1/16" OD tubing and offers a pressure rating of 5,000 psi (345 bar). Seal unused ports with any of our polymer 10-32 coned plugs on page 55.

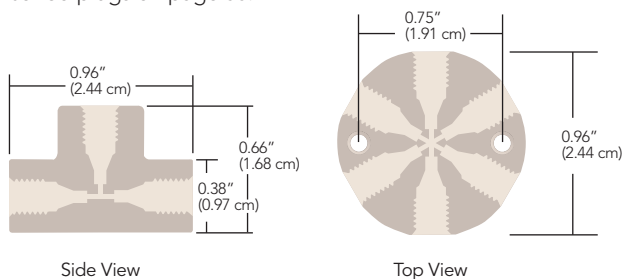

P-170
PEEK 7-Port Manifold 0.020" thru-holes with F-331 Fittings

Part No.	Description	Threads	Includes	Thru-hole	Swept Volume	Pressure Rating	Qty.
PEEK TEES AND CROSSES							
P-727	PEEK Tee for 1/16" OD Tubing	10-32 Coned	(3) F-300	0.020" (0.50 mm)	0.57 μ L	3,500 psi (241 bar)	ea.
P-728	PEEK Tee for 1/16" OD Tubing	10-32 Coned	(3) F-300	0.050" (1.25 mm)	3.0 μ L	3,500 psi (241 bar)	ea.
P-729	PEEK Cross for 1/16" OD Tubing	10-32 Coned	(4) F-300	0.020" (0.50 mm)	0.72 μ L	3,500 psi (241 bar)	ea.
PEEK MANIFOLD							
P-170	PEEK 7-Port Manifold for 1/16" OD Tubing	10-32 Coned	(7) F-331	0.020" (0.50 mm)	2.2 μ L	5,000 psi (345 bar)	ea.

High Pressure MicroTight® Unions

Conductive MicroTight Union

The Conductive MicroTight Union manufactured by IDEX Health & Science provides an excellent opportunity to introduce voltage into an electrospray or capillary electrophoresis system. With an extremely low internal volume of 16 nL, this union can be placed inline with 360 µm OD capillary tubing. Mount and apply voltage to these unions using our Insulating Mounting Bracket below.

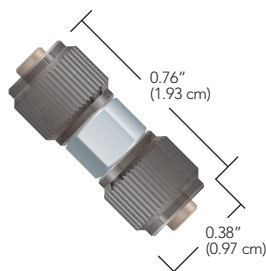

M-572
Conductive MicroTight Union for 360 µm OD tubing with fittings and Capsule Union included

APPLICATION NOTE

For an example of using a Conductive MicroTight Union in a pressure driven ion preconcentration application see: "Self-Sealed Vertical Polymeric Nanoporous Junctions for High Throughput Nanofluidic Applications."

Sun Jae Kim and Jong Yoon Han. *Analytical Chem.* 2008, 80: 3507-3511.

RELATED PRODUCTS

- » Easily integrate the Conductive MicroTight Union into your system with our Insulating Mounting Bracket, shown on page 79.

MicroTight® Connectors for Capillary Tubing

Connect two pieces of capillary tubing with our PEEK MicroTight Connectors. The True ZDV Unions allow two pieces of tubing to connect directly to each other — using the included gauge plug to ensure proper alignment. The standard union and elbow both feature a 0.006" (0.150 mm) thru-hole, adding only a small amount of additional flow-path volume to help ensure proper chromatographic results.

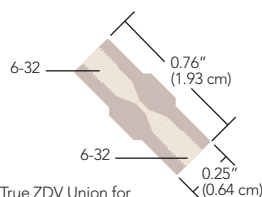

P-720
MicroTight True ZDV Union for use with MicroTight Sleeves with fittings and gauge plug included

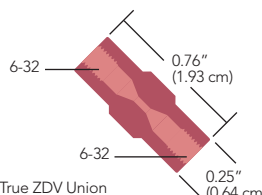

P-771
MicroTight True ZDV Union for 1/32" OD tubing with fittings and gauge plug included

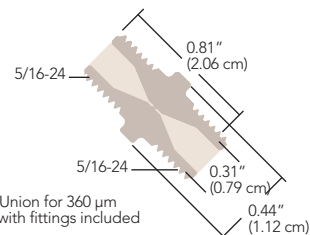

P-772
MicroTight Union for 360 µm OD tubing with fittings included

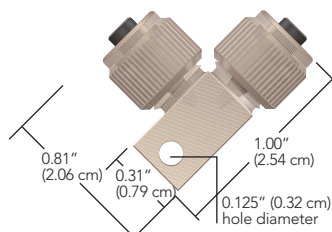

P-874
MicroElbow for MicroTight Tubing Sleeves with fittings included

Part No.	Description	Threads	Includes	Thru-hole	Swept Volume	Pressure Rating	Qty.
MICROTIGHT UNIONS							
P-720	PEEK True ZDV Union for MicroTight Sleeves	6-32 Coned	(2) F-125, (1) P-553	N/A	N/A	4,000 psi (276 bar)	ea.
P-771	PEEK True ZDV Union for 1/32" OD Tubing	6-32 Coned	(2) F-126S, (1) P-553	N/A	N/A	5,000 psi (345 bar)	ea.
P-772	PEEK Union for 360 µm OD Tubing	5/16-24 Coned	(2) F-152, (2) P-416BLK	0.006" (0.150 mm)	5 nL	5,000 psi (345 bar)	ea.
P-874	PEEK MicroElbow for MicroTight Sleeves	5/16-24 Coned	(2) F-172, (2) P-416	0.006" (0.150 mm)	20 nL	4,000 psi (276 bar)	ea.
REPLACEMENT GAUGE PLUGS (TO ACHIEVE TRUE ZDV CONNECTIONS WITH OUR P-720 AND P-771 UNIONS)							
P-553	Gauge Plug, Delrin®	6-32 Coned	N/A	N/A	N/A	N/A	ea.
CONDUCTIVE MICROTIGHT UNIONS							
M-572	Conductive Union for 360 µm OD Tubing, PEEK/SST	5/16-24 Coned	(2) F-152, (2) P-416BLK, (1) M-128NF	0.011" (0.279 mm)	16 nL	5,000 psi (345 bar)	ea.

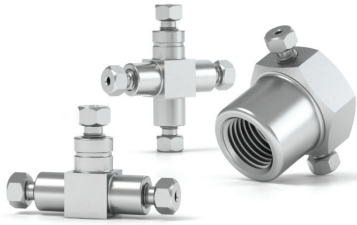

High Pressure Stainless Steel Tees & Crosses

These 316 stainless steel connectors come complete with 10-32 stainless steel fittings for use with 1/16" OD tubing and are rated to 20,000 psi (1,380 bar). They are compatible with any 10-32 coned threaded fittings.

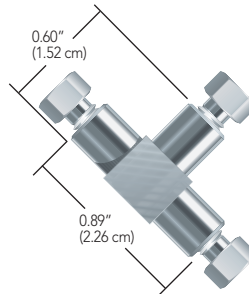

U-428 Stainless Steel Tee
0.020" thru-hole with U-400 and U-401 Fittings

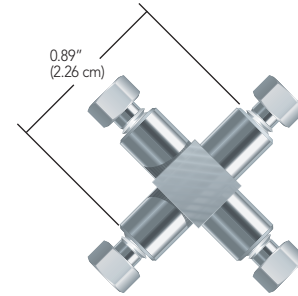

U-430 Stainless Steel Cross
0.020" thru-hole with U-400 and U-401 Fittings

Part No.	Description	Threads	Includes	Thru-hole	Swept Volume	Pressure Rating	Qty.
VHP TEE FOR 1/16" OD TUBING							
U-428	Stainless Steel Tee for 1/16" OD Tubing	10-32 Coned	(3) U-400, (3) U-401	0.020" (0.50 mm)	0.57 μ L	20,000 psi (1,380 bar)	ea.
U-429	Stainless Steel Tee for 1/16" OD Tubing	10-32 Coned	(3) U-400, (3) U-401	0.040" (1.00 mm)	2.1 μ L	20,000 psi (1,380 bar)	ea.
U-430	Stainless Steel Cross for 1/16" OD Tubing	10-32 Coned	(4) U-400, (4) U-401	0.020" (0.50 mm)	0.72 μ L	20,000 psi (1,380 bar)	ea.
U-431	Stainless Steel Cross for 1/16" OD tubing	10-32 Coned	(4) U-400, (4) U-401	0.040" (1.00 mm)	2.5 μ L	20,000 psi (1,380 bar)	ea.

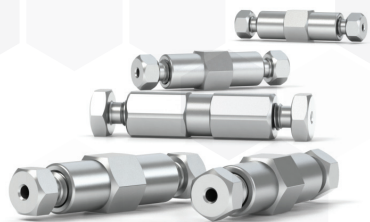

VHP Stainless Steel ZDV Unions

- › Supplied with fittings for 1/16" OD or 1/8" OD tubing
- › Manufactured from 316 stainless steel
- › All union assemblies rated to 20,000 psi (1,380 bar) or higher

NOTE

It is possible to order the products on this page without the fittings. Simply use a -01 at the end of the product number to order the union body without fittings.

Our high pressure, zero-dead-volume (ZDV) unions are precision machined from 316 stainless steel, carefully passivated, then thoroughly rinsed. Each comes complete with stainless steel nuts and ferrules.

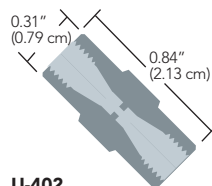
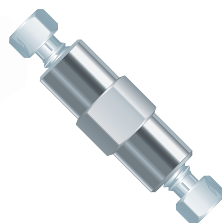

U-402
ZDV Union
0.020" thru-hole
for 1/16" OD tubing

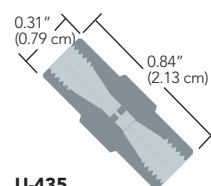

U-435
ZDV Union
0.010" thru-hole
for 1/16" OD tubing

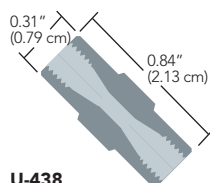

U-438
True ZDV Union
0.067" thru-hole
for 1/16" OD tubing



U-411
NanoTight™ Union
0.007" thru-hole
for 1/16" OD tubing

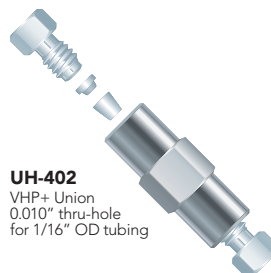

UH-402
VHP+ Union
0.010" thru-hole
for 1/16" OD tubing



U-322
VICI® (Valco) Compatible
ZDV Union 0.020" thru-hole
for 1/16" OD tubing

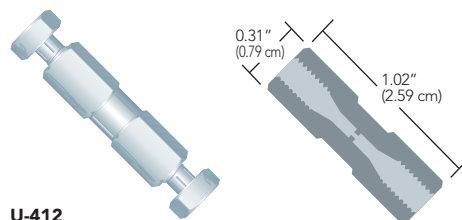

U-412
Waters Compatible
ZDV Union 0.020" thru-hole
for 1/16" OD tubing

Part No.	Description	Threads	Includes	Thru-hole	Swept Volume	Pressure Rating	Qty.
VHP STAINLESS STEEL ZDV UNIONS							
1593	Obsolete Stainless Steel Union for 1/8" OD Tubing	1/4-28 Coned	(2) C-235/C-236	0.050" (1.25 mm)	1.48 µL	20,000 psi (1,380 bar)	ea.
U-402	Stainless Steel Union for 1/16" OD Tubing	10-32 Coned	(2) U-400/U-401	0.020" (0.50 mm)	0.13 µL	20,000 psi (1,380 bar)	ea.
U-411	Stainless Steel Union for 1/16" OD Tubing	10-32 Coned	(2) U-400/U-401	0.007" (178 µm)	13 nL	20,000 psi (1,380 bar)	ea.
U-435	Stainless Steel Union for 1/16" OD Tubing	10-32 Coned	(2) U-400/U-401	0.010" (0.25 mm)	20 nL	20,000 psi (1,380 bar)	ea.
U-438	Stainless Steel Union for 1/16" OD Tubing	10-32 Coned	(2) U-400/U-401, (1) P-554 Gauge Plug	0.067" (1.70 mm)	Near 0 µL	20,000 psi (1,380 bar)	ea.
UH-402	VHP+ Stainless Steel Union for 1/16" OD Tubing	10-32 Coned	(2) VHP-200	0.010" (0.25 mm)	20 nL	30,000 psi (2,070 bar)	ea.
VICI (VALCO) COMPATIBLE ZDV UNION							
U-322	Stainless Steel Union for 1/16" OD Tubing	10-32 Coned	(2) U-320/U-321	0.020" (0.50 mm)	0.15 µL	20,000 psi (1,380 bar)	ea.
WATERS® COMPATIBLE ZDV UNION							
U-412	Stainless Steel Union for 1/16" OD Tubing	10-32 Coned	(2) U-410/U-401	0.020" (0.50 mm)	0.10 µL	20,000 psi (1,380 bar)	ea.

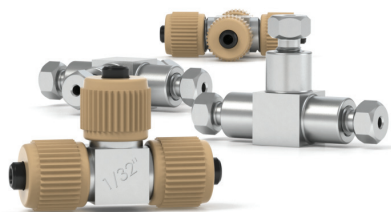

VHP Tees & Crosses

Our VHP Stainless Steel Tees and Crosses are precision machined from durable stainless steel. It is mechanically designed for bringing together three or four pieces of tubing. Our VHP Tees & Crosses have an extremely high pressure rating of 30,000 psi (2070 bar).

VHP Tees & Crosses for Capillary Tubing

- › Direct-connect either 360 μ m or 1/32" OD tubing — no sleeves required!
- › Available in both tee and cross configurations
- › Pressure rated to 15,000 psi (1,034 bar)

To help facilitate multi-port connections in UHPLC applications, our experts have developed a line of MicroTees and MicroCrosses, manufactured from stainless steel and featuring small thru-holes and very low internal volume. Additionally, the stainless steel construction allows these products to be used in applications where electrical conductivity is desired.

Included with the MicroTees and MicroCrosses are the VHP MicroFerrules found on page 59. The P-278 Extender Tool on page 33 can be used to tighten the female nuts that are included with these connectors.

APPLICATION NOTE

Why 1/32" OD Tubing and 360 μ m OD Tubing?

IDEX Health & Science has focused strongly on the development of a variety of connectors and accessories for 1/32" OD tubing and 360 μ m OD tubing. We have focused on these specific sizes due to their overwhelming popularity in analytical instruments, especially where micro and nano-scale analyses are being performed. By creating products designed for these popular sizes, the overall connection is easier to make and generally holds to increased pressures over connections where tubing sleeves are involved.

VHP Tee for 1/16" OD Tubing

IDEX Health & Science offers this Very High Pressure (VHP) Tee Connector, designed to bring three pieces of tubing together. The all-316 stainless steel connector is designed for 1/16" OD tubing and is pressure rated to 30,000 psi (2,070 bar).

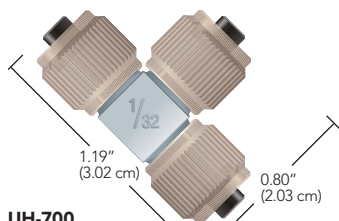

UH-700
VHP MicroTee
for 1/32" OD tubing
with fittings included

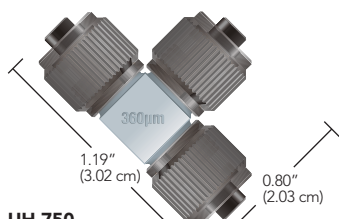

UH-750
VHP MicroTee
for 360 μ m OD tubing
with fittings included

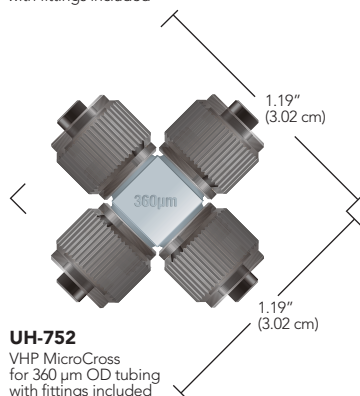

UH-752
VHP MicroCross
for 360 μ m OD tubing
with fittings included

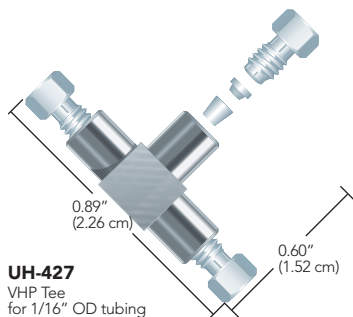

UH-427
VHP Tee
for 1/16" OD tubing
with fittings included

Part No.	Description	Threads	Includes	Thru-hole	Swept Volume	Pressure Rating	Qty.
VHP TEE FOR 1/16" OD TUBING							
UH-427	VHP Tee for 1/16" OD Tubing, SST	10-32 Coned	(3) VHP-200	0.020" (0.50 mm)	0.57 μ L	30,000 psi (2,070 bar)	ea.
VHP TEES & CROSSES FOR CAPILLARY TUBING							
UH-700	VHP MicroTee for 1/32" OD Tubing, PEEK/SST	5/16-24 Coned	(3) PK-112, (3) P-416	0.010" (0.25 mm)	84 nL	15,000 psi (1,034 bar)	ea.
UH-750	VHP MicroTee for 360 μ m OD Tubing, PEEK/SST	5/16-24 Coned	(3) PK-152, (3) P-416BLK	0.010" (0.25 mm)	84 nL	15,000 psi (1,034 bar)	ea.
UH-752	VHP MicroCross for 360 μ m OD Tubing, PEEK/SST	5/16-24 Coned	(4) PK-152, (4) P-416BLK	0.010" (0.25 mm)	101 nL	15,000 psi (1,034 bar)	ea.

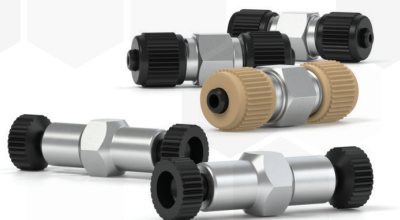

VHP MicroTight[®] Unions

- › Featuring stainless steel bodies and PK/PEEK fittings
- › Pressure rated up to 15,000 psi (1,034 bar)
- › Options to direct-connect both 1/32" OD tubing and 360 µm OD tubing

VHP Unions for Capillary Tubing

IDEX Health & Science has expanded its line of specialized fittings and connectors for UHPLC applications to include several innovative unions and adapters.

Two of these products — the UH-432 and UH-436 — follow the design of our popular Mini MicroFilters (see page 109) and allow a convenient union between either 1/32" OD tubing or 360 µm OD tubing. Each features a stainless steel union body and a unique stainless steel union capsule, enabling both excellent chemical compatibility as well as conductivity, making these a great choice for electrical interfacing in certain LC-MS applications. Each is also coupled with direct-connect ferrules made from our proprietary PEEK polymer blend (PK), allowing tubing connections up to 15,000 psi (1,034 bar). *(Please Note: While these connectors can be used at elevated pressures, they are not recommended for applications above 100 °C.)*

The UH-632 is a more traditionally designed connector, incorporating internally threaded ports. The union (UH-632) features a true ZDV (zero dead volume) connection between both tubes. This unique product is coupled with our one-piece Ultra-High Performance Fingertight fittings manufactured from our proprietary PEEK polymer blend, allowing them to be used in high temperature applications (up to 200 °C) at pressures up to 6,000 psi (414 bar) — or use these connectors at room temperature up to 15,000 psi (1,034 bar)!

The 1959-01 is a new VHP union designed to accept the popular M4x0.7 threaded fittings for 1/32" OD tubing. These unions will work nicely with both the VHP-900 fittings (found on page 59) as well as the reusable VHP-920 (found on page 60).

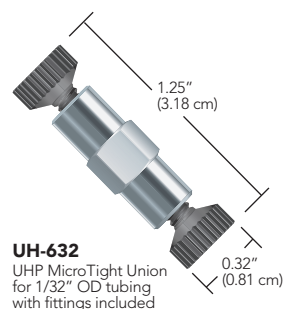
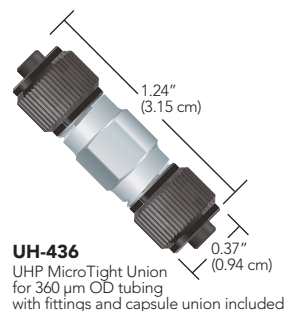
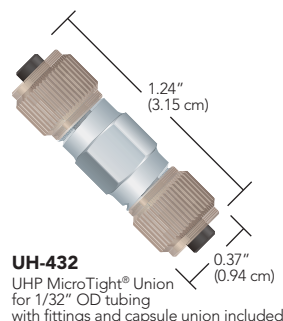

VHP MicroTight® Unions (Cont.)



APPLICATION NOTE

What is a True ZDV Union?

True zero dead volume (ZDV) unions are designed so that the two joined pieces of tubing butt perfectly together as shown in the image to the right. These products have no swept volume contained within the union body. The fluid moves directly from one tube into another in this type of connector.

When using true ZDV unions, it is important to take care to ensure connecting tubing has burr-free 90 degree ends. Find tubing cutters on page 28 to assist with cleanly cutting polymer and fused silica tubing. Gauge plugs are supplied with True ZDV Unions to assist with assembly. With the gauge plug inserted into one side of the union, a hard stop is created for the tubing to bottom out against as it is connected to the opposite port. The gauge plug is removed and then the second piece of tubing is connected, using the first piece of tubing to bottom out against resulting in the two tubes joined together in the center of the union.

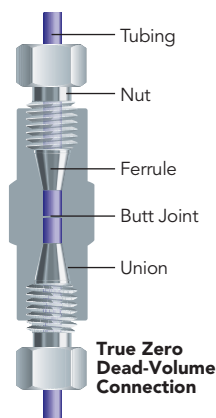

RELATED PRODUCTS

- › Find replacement VHP fittings on page 59.
- › Find Fused Silica tubing on page 16.
- › Find 1/32" OD Stainless Steel tubing on page 19.
- › To achieve 15,000 psi (1,034 bar) with the female threaded fittings used with some of these products, use the P-278 extender tool found on page 50.

VHP MicroTight Unions

Part No.	Description	Threads	Includes	Thru-hole	Swept Volume	Pressure Rating	Qty.
VHP UNIONS FOR CAPILLARY TUBING							
UH-432	VHP Union for 1/32" OD Tubing, PEEK/SST	5/16-24 Coned	(2) PK-112, (2) P-416	0.006" (0.150 mm)	5 nL	15,000 psi (1,034 bar)	ea.
UH-436	VHP Union for 360 µm OD Tubing, PEEK/SST	5/16-24 Coned	(2) PK-152, (2) P-416BLK	0.006" (0.150 mm)	5 nL	15,000 psi (1,034 bar)	ea.
UH-632	VHP True ZDV Union for 1/32" OD Tubing, PEEK/SST	6-32 Coned	(2) PK-126, (1) P-553 Gauge Plug	N/A	N/A	15,000 psi (1,034 bar)	ea.
1959-01	Obsolete VHP Union for 1/32" OD Tubing, SST	M4x0.7	N/A (Fittings must be ordered separately)	0.007" (178 µm)	16 nL	30,000 psi (2,070 bar)	ea.

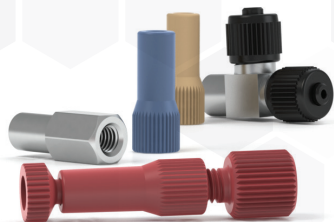

MicroTight[®] Adapters

- › Convenient adapters for common 1/16" OD to capillary tubing
- › Direct connect to 1/32" OD or 360 µm OD tubing options available
- › VHP adapters pressure rated to 12,000 psi (828 bar)

NOTE

While many 10-32 coned fittings are interchangeable, coned fittings using different threads are generally not interchangeable. As such, IDEX Health & Science recommends that only the style of coned fittings that accompanies these connectors be used for replacements.

Create a true zero dead volume (ZDV) connection between 1/16" OD tubing and capillary tubing with our MicroTight Adapters.

For Very High Pressure applications the UH-630 will connect 1/16" OD to 1/32" OD tubing in an inline true ZDV connection with the ability to withstand 12,000 psi (828 bar)! The materials of construction also allow this product to be used up to 200 °C, which reduces the pressure rating to 8,000 psi (552 bar). For more information on the fittings used with the VHP adapter, please see page 59.

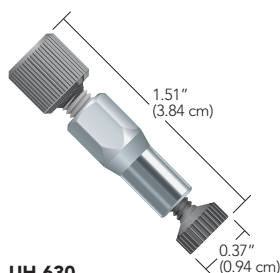

UH-630
VHP MicroTight Adapter for 1/16" and 1/32" OD tubing with fittings included



UH-634
VHP MicroTight Adapter for 1/16" and 360 µm OD tubing with fittings included

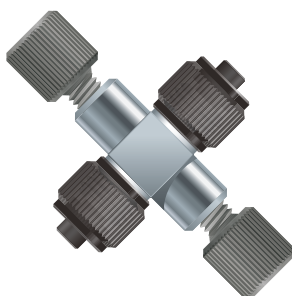

UH-906
VHP MicroTight Adapting Cross 10-32 Coned for 1/16" OD tubing and 5/16-24 Coned for 360 µm OD tubing

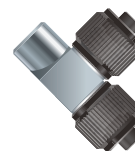

UH-753
VHP MicroTight Adapting Tee 360 µm (2 ports) to 10-32 C for 1/16" OD tubing (1 port)



UH-631-01
VHP MicroTight Adapter 10-32 Coned for 1/16" OD tubing and 6-40 Coned for 1/32" OD tubing fittings not included

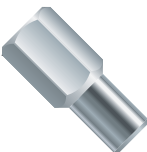

1958-01
VHP MicroTight Adapter 10-32 Coned for 1/16" OD tubing and M4x0.7 for 1/32" OD tubing

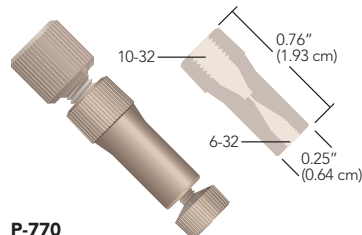

P-770
MicroTight ZDV Adapter for 1/16" OD to MicroTight Sleeves with fittings included

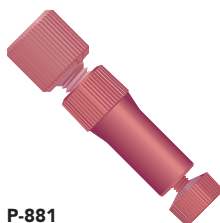

P-881
MicroTight ZDV Adapter for 1/16" to 1/32" OD tubing with fittings included

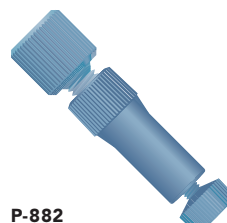

P-882
MicroTight ZDV Adapter for 1/16" to 360 µm OD tubing with fittings included

MicroTight® Adapters (Cont.)



RELATED PRODUCTS

- › Replacement 6-32 fittings are on page 34.
- › Replacement F-120 style nuts are on page 32 (when ordering, replace the “x” with an “R” or “B” to order either red or blue fittings).
- › Use this list to find micro flow products outside this chapter.

	Page
360 µm, 510 µm (0.020”), and 1/32” OD PEEK Tubing	16
360 µm OD Fused Silica Tubing	16
1/16” and 1/32” OD PEEKsil™ Tubing	22
1/32” OD FEP Tubing	26
360 µm OD High Purity PFA Tubing	24
510 µm (0.020”) and 1/32” OD Stainless Steel Tubing	19
Polymer Capillary and Fused Silica Tubing Cutters	28
MX Series II™ Injection and Switching Valves	119
Manual Injection Valves	121
Micro Injection Port Adapters	132
Micro-Splitter Valves	140
Micro-Metering Valves	141
Microbore Guard Column	158
Ultra-Low Volume Back-Pressure Regulators	144
Nonmetallic 10-32 Micro-Volume Inline Check Valve	137

MicroTight® Adapters

Part No.	Description	Threads	Includes	Color	Swept Volume	Pressure Rating	Qty.
MICROTIGHT ADAPTERS							
P-770	PEEK Micro Adapter, True ZDV, for 1/16” OD Tubing to MicroTight Tubing Sleeve	10-32 C to 6-32 C	(1) F-120, (1) F-125, (1) P-554	Natural	N/A	4,000 psi (276 bar)	ea.
P-881	PEEK Micro Adapter, True ZDV, for 1/16” to 1/32” OD Tubing	10-32 C to 6-32 C	(1) F-120R, (1) F-126S, (1) P-554	Red	N/A	5,000 psi (345 bar)	ea.
P-882	PEEK Micro Adapter, True ZDV, for 1/16” to 360 µm OD Tubing	10-32 C to 6-32 C	(1) F-120B, (1) F-124S, (1) P-554	Blue	N/A	5,000 psi (345 bar)	ea.
UH-630	Stainless Steel VHP Micro Adapter, for 1/16” to 1/32” OD Tubing	10-32 C to 6-32 C	(1) PK-120BLK, (1) PK-126, (1) P-554	SST/Black	N/A	12,000 psi (827 bar)	ea.
UH-634	Stainless Steel VHP Micro Adapter, for 1/16” to 360 µm OD Tubing	10-32 C to 6-32 C	(1) PK-120BLK, (1) PK-124, (1) P-554	SST/Black	N/A	12,000 psi (827 bar)	ea.
UH-753	Stainless Steel VHP Micro Adapting Tee, for 1/16” to 360 µm OD Tubing	10-32 C to 5/16-24 C	(2) P-416BLK, (2) PK-152	SST/Black	152 nL	15,000 psi (1,035 bar)*	ea.
1958-01	Stainless Steel VHP Micro Adapter, for 1/16” to 1/32” OD Tubing	10-32 C to M4x0.7 C	N/A	SST	16 nL	30,000 psi (2,070 bar)*	ea.
UH-631-01	Stainless Steel VHP Micro Adapter, for 1/16” to 1/32” OD Tubing	10-32 C to 6-40 C	N/A	SST	13 nL	30,000 psi (2,070 bar)*	ea.
UH-906	Stainless Steel VHP Micro Adapting Cross, for 1/16” to 360 µm OD Tubing	10-32 C to 5/16-24 C	(2) PK-120BLK, (2) P-416BLK, (2) PK-152	SST/Black	0.11 µL	15,000 psi (1,035 bar)*	ea.
REPLACEMENT GAUGE PLUGS (TO ACHIEVE TRUE ZDV CONNECTIONS WITH THE ABOVE ADAPTERS)							
P-554	Delrin® Gauge Plug	10-32 C		White	N/A	N/A	ea.
C = Coned							
* Pressure rating depends upon the fitting used.							



Accessories

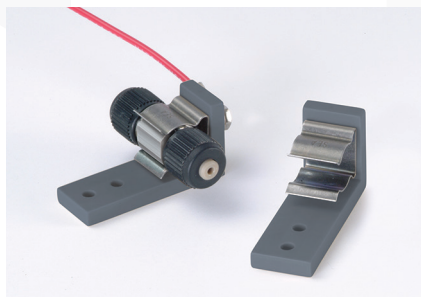

Insulating Mounting Bracket, shown with lead wire and Conductive MicroTight Union, not included.

Insulating Mounting Bracket

Use our Insulating Mounting Bracket to easily integrate the Conductive MicroTight Union (shown on page 71) or our Conductive Mini MicroFilters (on page 109) into your system or lab.

The product snaps into place. Voltage from your lead wire is conducted through the attaching stainless steel nut and screw (included), then onto the mounted product via the stainless steel clip.

The bracket's base includes two holes (#2 screw clearance) for easy mounting onto any lab surface. Dimensions are 1.25" L x 0.45" W x 0.63" H.

Part No.	Description	Threads	Includes	Thru-hole	Swept Volume	Pressure Rating	Qty.
INSULATING MOUNTING BRACKET							
M-447	Insulating Mounting Bracket	N/A	N/A	N/A	N/A	N/A	ea.

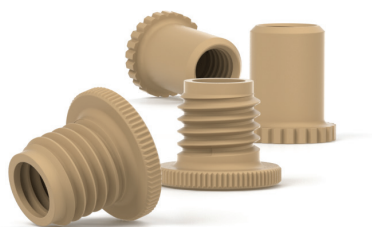

NanoPort Assemblies

- › For lab-on-a-chip applications
- › Options to connect 1/16" OD Tubing directly, or 360µm and 1/32" OD Tubing with tubing sleeves
- › **Wetted materials:**
PEEK and perfluoroelastomer

NanoPort Assemblies provide consistent fluid connections for chip-based analyses. NanoPort connections will bond to a variety of substrate materials with the use of Loctite.™

All NanoPort components are made of inert, biocompatible PEEK polymer (nuts and ports), Perlast® perfluoroelastomer (gaskets), and ETFE (ferrules). Their unique design also prevents adhesive contamination of the fluid path. And NanoPort connections add no additional volume to the fluid path, virtually eliminating dead volume traditionally associated with chip-based fluid connections.

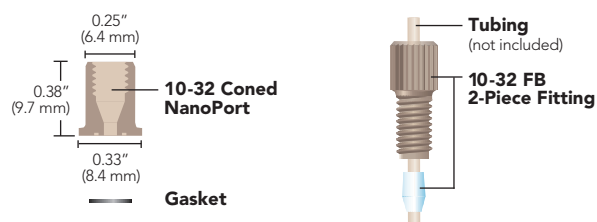

NOTE

Our NanoPort Assembly will readily connect 1/16" OD tubing with the included fittings. To connect 1/32" OD or 360µm OD, tubing sleeves for each size are included in each assembly.

Adhesive is not included in the N-333 NanoPort Assembly. Please contact IDEX Health & Science for bonding information or use common bonding adhesives such as Loctite.

Part No.	Description	Threads	For Chip Hole	Tubing OD	Qty.
NANOPORT ASSEMBLIES					
10-32 Coned NanoPort Assembly					
N-333	F-333N	F-142N	Up to 0.063" (1.6 mm)	1/16"	ea.
NANOPORT REPLACEMENT PARTS					
F-333Nx	Headless Fittings	10-32 C	Up to 0.063" (1.6 mm)	1/16"	10-pk
F-142Nx	Ferrules	10-32 C	Up to 0.063" (1.6 mm)	1/16"	10-pk
Gaskets					
N-123-02	Gasket, For all assemblies except 6-32 Coned Assemblies		N/A	N/A	ea.

Low Pressure Manifolds



Choose a 5, 7, or 9 Port Manifold to combine several streams into one, or split one fluid stream into several. Each PEEK manifold comes complete with 1/4-28 Super Flangeless™ Fittings for either 1/16" or 1/8" OD tubing, with pressure ratings of 2,000 psi (138 bar) and 500 psi (34 bar), respectively.

A few useful applications include:

- › Multiport mixing chamber
- › Gas sparging splitting union
- › Sample injection onto multi-well plates or a multiple direction flow path union

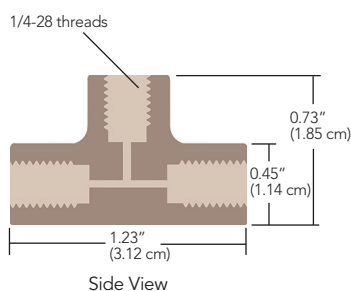

P-150
PEEK 7-Port Manifold
comes with Super Flangeless Fittings

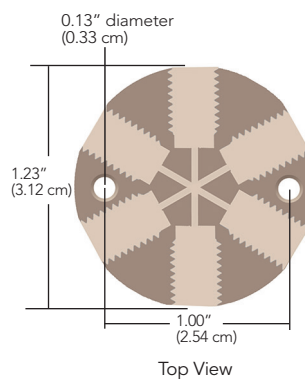

Part No.	Description	Threads	Includes	Thru-hole	Swept Volume	Pressure Rating	Qty.
MANIFOLDS							
Standard							
P-150	PEEK 7-Port Manifold for 1/16" OD Tubing	1/4-28 FB	(7) P-255, (7) P-250	0.040" (1.00 mm)	42.0 µL	1,000 psi (69 bar)	ea.
P-154	PEEK 5-Port Manifold for 1/16" OD Tubing	1/4-28 FB	(5) P-255, (5) P-250	0.040" (1.00 mm)	22.3 µL	1,000 psi (69 bar)	ea.
P-155	PEEK 5-Port Manifold for 1/8" OD Tubing	1/4-28 FB	(5) P-331, (5) P-359	0.062" (1.60 mm)	53.8 µL	500 psi (34 bar)	ea.
P-190	PEEK 9-Port Manifold for 1/8" OD Tubing	1/4-28 FB	(9) P-331, (9) P-359	0.062" (1.60 mm)	160 µL	500 psi (34 bar)	ea.
P-191	PEEK 9-Port Manifold for 1/16" OD Tubing	1/4-28 FB	(9) P-255, (9) P-250	0.040" (1.00 mm)	139 µL	1,000 psi (69 bar)	ea.

FB = Flat Bottom

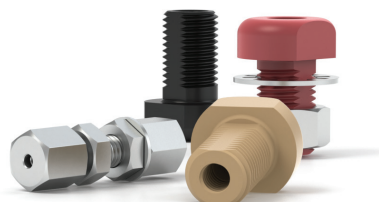

Low Pressure Bulkhead Unions

- › Designed for plumbing tubing through equipment housing
- › For use with standard 10-32 coned or 1/4-28 flat-bottom threaded fittings

Thread PEEK Bulkhead Unions directly through your equipment housing to connect internal tubing to the outside. Each union has unique 3/8-24 external threads and comes complete with a stainless steel nut and lock washer to hold it in place. Requires a 3/8" hole to mount. The recommended torque limit for these unions is 15 in.-lbs (1.7 N-m).

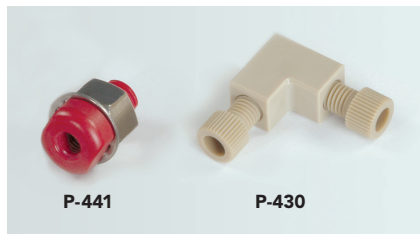

P-441

P-430

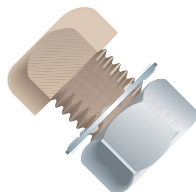

Bulkhead Union
includes stainless steel nut/lock washer

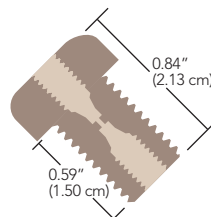

P-440
10-32 internal threads

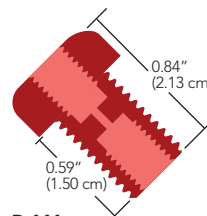

P-441
1/4-28 internal threads

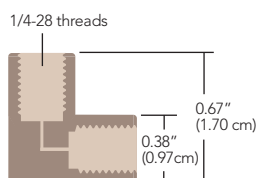

P-430
PEEK Elbow comes with Flangeless Fittings

Elbow Connectors

Use these Elbow Connectors to easily navigate tight corners. One Elbow is designed for use with 1/16" OD tubing and has a 0.020" (0.50 mm) thru-hole. Use 1/8" OD tubing with the other Elbow, which has a 0.062" (1.6 mm) thru-hole. Both come complete with 1/4-28 PEEK nuts and ETFE ferrules, and are pressure rated to 1,000 psi (69 bar).

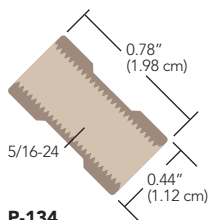

P-134
PEEK ZDV Union

Large Bore Union

- › 5/16-24 flat-bottom threads

Use any of the 5/16-24 fittings on page 55 and the appropriate ferrule to create a true zero dead volume (ZDV) connection with the P-134 Union.



RELATED PRODUCTS

- › Stainless Steel Bulkhead Unions are also available. Please contact us for more information.
- › To use Elbows in higher pressure applications, simply replace the provided fittings with Super Flangeless™ Nuts and Ferrules, found on page 39.

Part No.	Description	Threads	Color	Includes	Thru-hole	Swept Volume	Qty.
BULKHEAD UNIONS							
P-440	PEEK Bulkhead Union	10-32 Coned	Natural	(1) SST Nut/Washer	0.020" (0.50 mm)	1.9 µL	ea.
P-441	PEEK Bulkhead Union	1/4-28 Flat-Bottom	Red	(1) SST Nut/Washer	0.040" (1.00 mm)	2.9 µL	ea.
P-441N	PEEK Bulkhead Union	1/4-28 Flat-Bottom	Natural	(1) SST Nut/Washer	0.040" (1.00 mm)	2.9 µL	ea.
ELBOW CONNECTORS							
P-430	PEEK Elbow for 1/16" OD Tubing	1/4-28 Flat-Bottom	Natural	(2) XP-235	0.020" (0.50 mm)	1.4 µL	ea.
P-432	PEEK Elbow for 1/8" OD Tubing	1/4-28 Flat-Bottom	Natural	(2) XP-335	0.062" (1.60 mm)	13.6 µL	ea.
LARGE BORE UNION							
P-134	PEEK True ZDV Union	5/16-24 Flat-Bottom	Natural	N/A	N/A	N/A	ea.

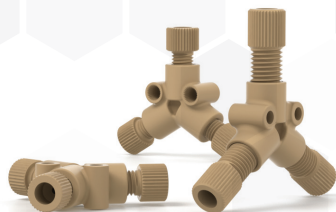

Low Pressure Y Connectors

PEEK Y Connectors are designed to split a stream or join two streams together, just like a tee. However, the configuration of a tee can lead to turbulent flow and solvent outgassing, which increases baseline noise and reduces sensitivity. The geometry of a Y connector creates less turbulence and thus can improve analytical results.

All of these Y Connectors use 1/4-28 Flangeless fittings, except P-515 which uses 5/16-24 fittings (to accommodate larger tubing).

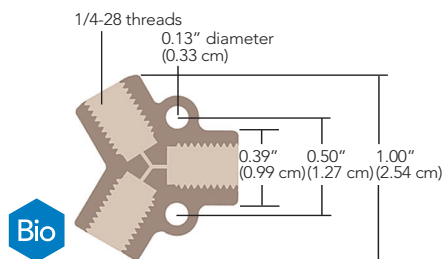

P-512
PEEK Y comes with Flangeless Fittings

Part No.	Description	Threads	Includes	Thru-hole	Swept Volume	Pressure Rating	Qty.
Y CONNECTORS							
P-512	PEEK Y for 1/16" OD Tubing	1/4-28 FB	(3) XP-235	0.020" (0.50 mm)	1.7 μ L	1,000 psi (69 bar)	ea.
P-513	PEEK Y for 1/8" OD Tubing	1/4-28 FB	(3) XP-335	0.040" (1.00 mm)	6.0 μ L	500 psi (34 bar)	ea.
P-514	PEEK Y for 1/8" OD Tubing	1/4-28 FB	(3) XP-335	0.060" (1.50 mm)	13.6 μ L	500 psi (34 bar)	ea.
P-515	PEEK Y for 3/16" OD Tubing	5/16-24 FB	(3) XP-132	0.125" (3.20 mm)	47.7 μ L	500 psi (34 bar)	ea.

FB = Flat-Bottom



Low Pressure Unions

- › Manufactured from PEEK, ETFE, Delrin®, polypropylene, or PCTFE
- › Available with 1/4-28, M6, or 10-32 flat-bottom threads

Our Low Pressure Unions are available in a variety of polymers, providing several low-cost and chemically-resistant options. The union assemblies below include fittings as shown in the table. The unions in the right column do not include fittings, allowing for customizing the fitting selection. In some cases, a union can be configured to connect two different tubing sizes—for example, if 1/4-28 Flangeless fittings for 1/16" and 1/8" OD tubing were selected from page 45 they can be used with the P-603 union to connect the two different tubing sizes.

Low Pressure PEEK Union Assemblies

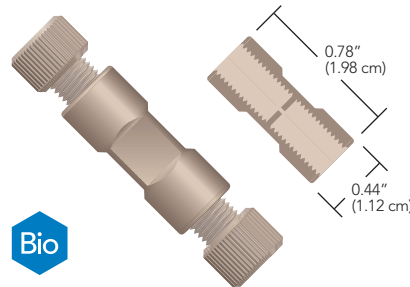

P-702 & P-703
PEEK Unions with Flangeless Fittings
(1/4-28 internal threads)

Low Pressure ETFE Union Assemblies

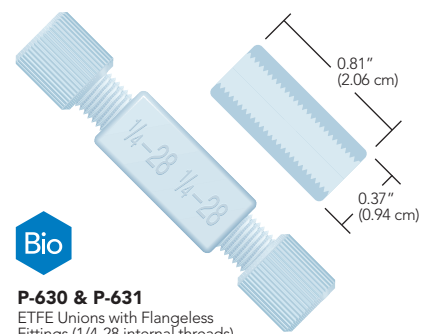

P-630 & P-631
ETFE Unions with Flangeless Fittings
(1/4-28 internal threads)

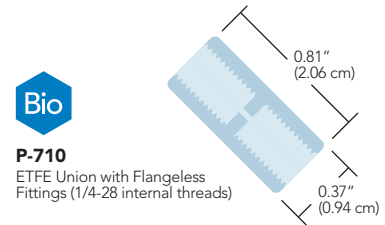

P-710
ETFE Union with Flangeless Fittings
(1/4-28 internal threads)

Low Pressure Standard Unions

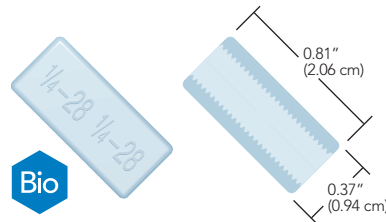

P-603, P-620 & P-623
Standard Unions (1/4-28 internal threads)

Low Pressure Metric Unions

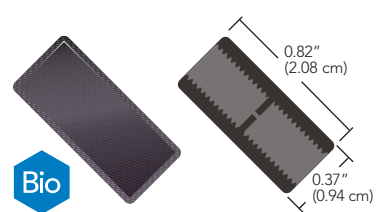

P-602 & P-622
Metric Unions (M6 internal threads)

Low Pressure Male Union

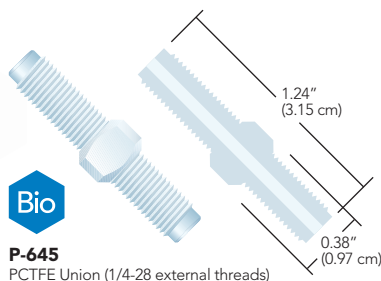

VacuTight™ Union

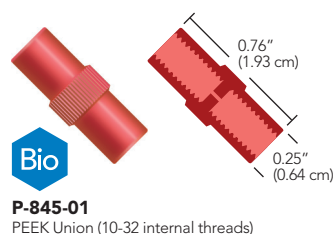

RELATED PRODUCTS

- › To use connectors in higher pressure applications, simply replace the provided fittings with Super Flangeless™ Nuts and Ferrules, found on page 39.
- › Use any of the 10-32 flat-bottom fittings on 39 and 42 to make an inline connection with our VacuTight Union. This product is designed for use with 1/16" OD tubing.

Low Pressure Unions

Part No.	Description	Color	Threads	Includes	Thru-hole	Swept Volume	Pressure Rating	Qty.
PEEK UNION ASSEMBLIES								
P-702	PEEK Union for 1/16" OD Tubing	Natural	1/4-28 FB	(2) XP-235	0.020" (0.50 mm)	0.41 µL	1,000 psi (69 bar)	ea.
P-703	PEEK Union for 1/8" OD Tubing	Natural	1/4-28 FB	(2) XP-335	0.050" (1.25 mm)	2.57 µL	1,000 psi (69 bar)	ea.
ETFE UNION ASSEMBLIES								
P-630	ETFE True ZDV Union for 1/16" OD Tubing	Natural	1/4-28 FB	(2) P-200N/P-245	N/A	N/A	1,000 psi (69 bar)	ea.
P-631	ETFE True ZDV Union for 1/8" OD Tubing	Natural	1/4-28 FB	(2) P-300N/P-345	N/A	N/A	1,000 psi (69 bar)	ea.
P-710	ETFE Union for 1/16" OD Tubing	Natural	1/4-28 FB	(2) XP-245	0.030" (0.75 mm)	0.93 µL	1,000 psi (69 bar)	ea.
STANDARD UNIONS								
P-603	Delrin True ZDV Standard Union	Natural	1/4-28 FB	N/A	N/A	N/A	N/A*	ea.
P-620	Polypropylene True ZDV Standard Union	Natural	1/4-28 FB	N/A	N/A	N/A	N/A*	ea.
P-623	ETFE True ZDV Standard Union	Natural	1/4-28 FB	N/A	N/A	N/A	N/A*	ea.
METRIC UNIONS								
P-602	Delrin Metric Union	Black	M6 FB	N/A	0.020" (0.50 mm)	0.41 µL	N/A*	ea.
P-622	ETFE Metric Union	Blue	M6 FB	N/A	0.020" (0.50 mm)	0.41 µL	N/A*	ea.
MALE UNION								
P-645	PCTFE Male Union	Natural	1/4-28 FB	N/A	0.062" (1.60 mm)	61.3 µL	500 psi (34 bar)	ea.
VACUTIGHT UNION								
P-845-01	PEEK Union for 1/16" OD Tubing	Red	10-32 FB	N/A	0.020" (0.50 mm)	0.20 µL	N/A*	ea.

* Pressure Rating depends on Fittings selected. See pressure rating for fittings on appropriate page.
FB = Flat-Bottom

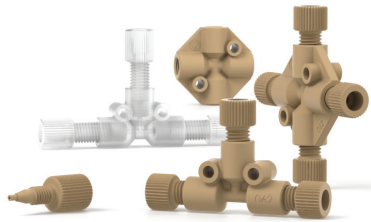

Low Pressure Tees & Crosses

Our Low Pressure Tees and Crosses are available in two inert polymers and can handle pressures to 500 psi (34 bar) or 1,000 psi (69 bar), depending upon the configuration of the products. Each is designed with handy mounting holes. All ETFE Tees and Crosses ship complete with 1/4-28 PFA Flangeless nuts and ETFE ferrules, while their PEEK polymer counterparts ship with 1/4-28 PEEK nuts and ETFE ferrules. Replacement fittings are located on page 47.

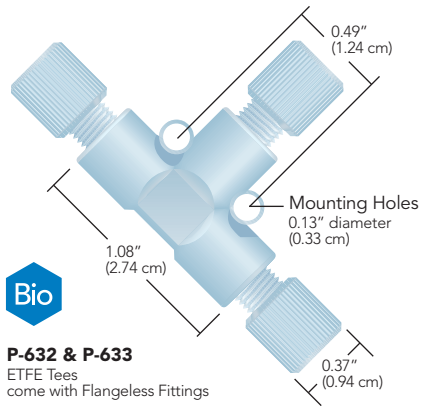

P-632 & P-633
ETFE Tees
come with Flangeless Fittings

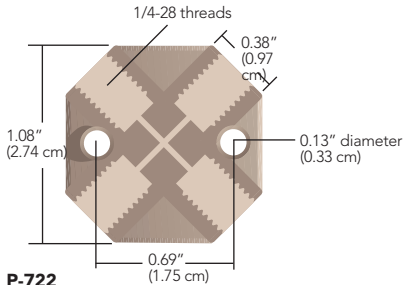

P-722
PEEK Cross
comes with Flangeless Fittings

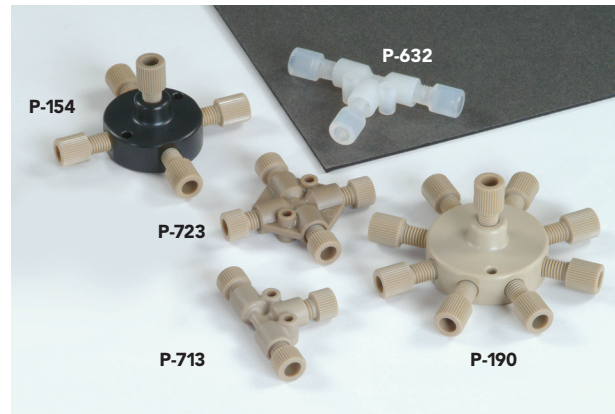

RELATED PRODUCTS

- › Seal off unused ports with any of our 1/4-28 flat-bottom plugs found on page 55.
- › To use the PEEK polymer versions of our Tees and Crosses in higher pressure applications, simply replace the provided fittings with Super Flangeless™ Nuts and Ferrules, found on page 39.
- › High Pressure Tees, Crosses, and a 7-Port Manifold (all with 10-32 threaded ports) are on page 74.

NOTE

- › To order just the body of one of our tees and crosses without fittings, simply add a '-01' to the part number — e.g., P-632-01.

Part No.	Description	Threads	Includes	Thru-hole	Swept Volume	Pressure Rating	Qty.
LOW PRESSURE TEES AND CROSSES							
P-632	ETFE Tee for 1/16" OD Tubing	1/4-28 Flat-Bottom	(3) P-245, (3) P-200N	0.020" (0.50 mm)	2.9 µL	1,000 psi (69 bar)	ea.
P-633	ETFE Tee for 1/8" OD Tubing	1/4-28 Flat-Bottom	(3) P-345, (3) P-300N	0.050" (1.25 mm)	17.5 µL	500 psi (34 bar)	ea.
P-634	ETFE Cross for 1/16" OD Tubing	1/4-28 Flat-Bottom	(4) P-245, (4) P-200N	0.020" (0.50 mm)	3.8 µL	1,000 psi (69 bar)	ea.
P-635	ETFE Cross for 1/8" OD Tubing	1/4-28 Flat-Bottom	(4) P-345, (4) P-300N	0.050" (1.25 mm)	22.8 µL	500 psi (34 bar)	ea.
P-712	PEEK Tee for 1/16" OD Tubing	1/4-28 Flat-Bottom	(3) XP-235	0.020" (0.50 mm)	2.9 µL	1,000 psi (69 bar)	ea.
P-713	PEEK Tee for 1/8" OD Tubing	1/4-28 Flat-Bottom	(3) XP-335	0.050" (1.25 mm)	17.5 µL	500 psi (34 bar)	ea.
P-714	PEEK Tee for 1/16" OD Tubing	1/4-28 Flat-Bottom	(3) XP-235	0.040" (1.00 mm)	11.4 µL	1,000 psi (69 bar)	ea.
P-722	PEEK Cross for 1/16" OD Tubing	1/4-28 Flat-Bottom	(4) XP-235	0.020" (0.50 mm)	3.8 µL	1,000 psi (69 bar)	ea.
P-723	PEEK Cross for 1/8" OD Tubing	1/4-28 Flat-Bottom	(4) XP-335	0.050" (1.25 mm)	22.8 µL	500 psi (34 bar)	ea.



Quick Connect Luer Adapters

- › Delrin®, polypropylene, ETFE, or PEEK Versions
- › Adapts luers to 1/4-28, 10-32, 5/16-24, or M6 threaded ports

These luer adapters were designed to work in a variety of applications. By connecting any male luer to any female luer, you can create your own quick connect union or adapter. Each Quick Connect Luer Adapter conforms to ISO requirements for medical luer taper configuration and performance (45 psi/3.1 bar).

Find fittings to connect tubing to the threaded ports of these adapters in the Fittings chapter, starting on page 30.

Please Note: Our Female Quick Connect Luer Adapters can be used with any of the Male Luers on this page, i.e., those with and without lock hubs.



APPLICATION NOTE

- › Our A-626 Bottle Cap Plug (page 55) can be used to plug any of the female luer adapters on this page.
- › To prevent a chemical spill when disconnecting your solvent reservoir tubing from the pump, try our Quick-Stop Luer Check Valve on page 139.
- › To economically prime an HPLC pump, simply remove the 10-32 fitting on the outlet check valve (standard on most models), insert a P-642 luer adapter, attach a syringe (such as our B-310) and draw the mobile phase through the pump head.

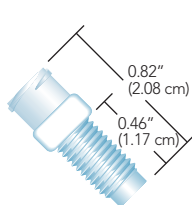

P-604, P-618, P-624
Female Luer to 1/4-28 Male
(luer end of P-604 different than shown)

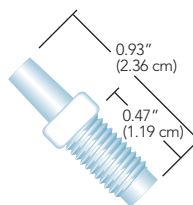

P-619, P-625
Male Luer to 1/4-28 Male

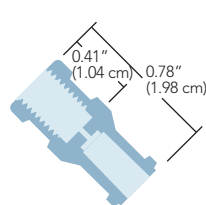

P-628
Female Luer to 1/4-28 Female

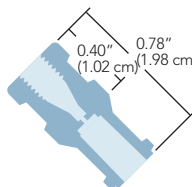

P-629
Female Luer to 10-32 Female

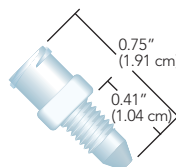

P-642
Female Luer to 10-32 Male

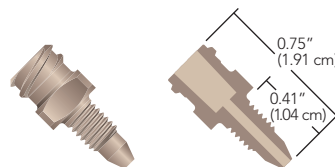

P-719
Female Luer to 10-32 Male

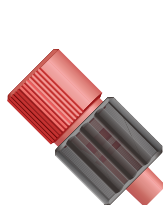

P-655, P-675
Male Luer to 1/4-28 Female

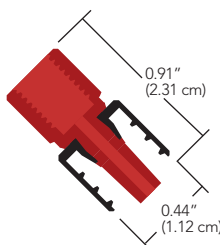

P-656
Male Luer to 10-32 Female

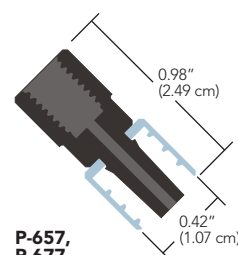

P-657, P-677
Male Luer to M6 Female

Quick Connect Luer Adapters (Cont.)

Luer-To-MicroTight® Adapter

› Easily connect 360 µm OD tubing to a syringe



P-662 Luer-to-MicroTight Adapter, shown with a B-310 Syringe (see table below) and PEEK capillary tubing (page 16), not included.

The Luer-to-MicroTight Adapter is ideal for infusing sample into lab-on-a-chip devices. This product is made entirely of biocompatible PEEK polymer and introduces only 14 nL of additional volume to the flow path. Use it to directly connect a luer-tip syringe or other product that terminates with a standard male luer to 360 µm OD capillary tubing without tubing sleeves (see photo). MicroTight Fittings are included.

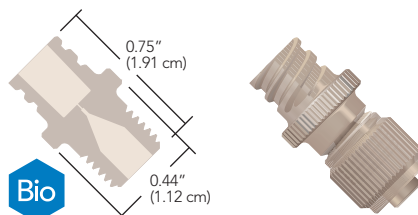

P-662
Luer-To-MicroTight Adapter for Luer to 360 µm OD tubing with fittings included

Quick Connect Luer Adapters

Part No.	Description	Body Material	Lock Hub Material	Thru-hole	Qty.
QUICK CONNECT LUER ADAPTERS					
P-604	F Luer to 1/4-28 FB, M	Nat. Delrin	N/A	0.05" (1.3 mm)	ea.
P-618	F Luer to 1/4-28 FB, M	Nat. PP	N/A	0.05" (1.3 mm)	ea.
P-619	M Luer to 1/4-28 FB, M	Nat. PP	None *	0.05" (1.3 mm)	ea.
P-624	F Luer to 1/4-28 FB, M	Nat. ETFE	N/A	0.05" (1.3 mm)	ea.
P-625	M Luer to 1/4-28 FB, M	Nat. ETFE	None *	0.04" (1.0 mm)	ea.
P-628	F Luer to 1/4-28 FB, F	Nat. ETFE	N/A	0.04" (1.0 mm)	ea.
P-629	F Luer to 10-32 C, F	Nat. ETFE	N/A	0.04" (1.0 mm)	ea.
P-642	F Luer to 10-32 C, M	Nat. ETFE	N/A	0.05" (1.3 mm)	ea.
P-655	M Luer to 1/4-28 FB, F	Red PEEK	Black PEEK	0.04" (1.3 mm)	ea.
P-656	M Luer to 10-32 C, F	Nat. PEEK	Black PEEK	0.05" (1.3 mm)	ea.
P-657	M Luer to M6 FB, F	Black PEEK	Black PEEK	0.05" (1.3 mm)	ea.
P-658	F Luer to 1/4-28 FB, F	Red PEEK	N/A	0.05" (1.3 mm)	ea.
P-659	F Luer to 10-32 C, F	Nat. PEEK	N/A	0.05" (1.3 mm)	ea.
P-660	F Luer to M6 FB, F	Black PEEK	N/A	0.05" (1.3 mm)	ea.
P-661	F Luer to 5/16-24 FB, M	Nat. ETFE	N/A	0.05" (1.3 mm)	ea.
P-675	M Luer to 1/4-28 FB, F	Red ETFE	Natural PP	0.05" (1.3 mm)	ea.
P-677	M Luer to M6 FB, F	Black ETFE	Natural PP	0.05" (1.3 mm)	ea.
P-678	F Luer to 1/4-28 FB, F	Red ETFE	N/A	0.05" (1.3 mm)	ea.
P-680 Obsolete	F Luer to M6 FB, F	Black ETFE	N/A	0.05" (1.3 mm)	ea.
P-683	M Luer to 1/4-28 FB, M	Nat. PEEK	Black PEEK	0.04" (1.0 mm)	ea.
P-686	F Luer to M6 FB, M	Black ETFE	N/A	0.05" (1.3 mm)	ea.
P-719	F Luer to 10-32 C, M	Nat. PEEK	N/A	0.05" (1.3 mm)	ea.
SYRINGE WITH MALE LUER LOCK					
B-310	10 cc Disposable Luer-Lock Syringe. For use with any Female Luer Adapter			0.05" (1.3 mm)	ea.
LUER-TO-MICROTIGHT ADAPTER					
P-662	Luer-to-MicroTight Adapter	(1) F-152, (1) P-416	0.006" (0.150 mm)	45 psi (2.4 bar)	ea.

F = Female (internal) threads; M = Male (external) threads; Nat. = Natural; N/A = Not Applicable;
PP = Polypropylene; FB = Flat-Bottom; C = Coned
* Slip-type male luer.

LuerTight[™] Fittings

- › Luer fittings for fluoropolymer tubing
- › Quick disconnect and barbless
- › For 1/16" and 1/8" OD tubing

Our LuerTight fittings are specifically designed to connect fluoropolymer tubing without barbs or nuts! By integrating ferrules into the luer bodies, LuerTights will reliably hold your tubing in place while giving you the convenience of a luer connection. An inline set of LuerTight fittings provides a quick and easy disconnection option. LuerTight connections are also less bulky and more economical than nut-to-luer style fittings.

The bodies of these products are manufactured from polypropylene and the ferrules, where used, are made of ETFE.

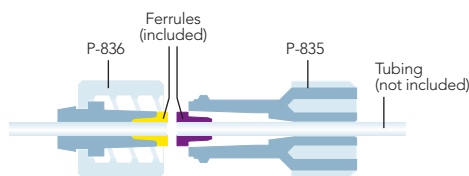

P-837
LuerTight Fittings System for 1/16" OD tubing

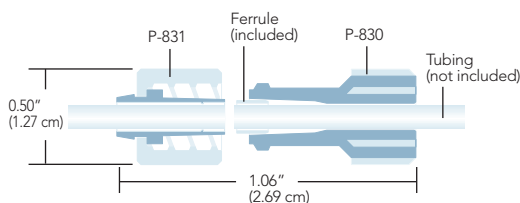

P-838
LuerTight Fittings System for 1/8" OD tubing



NOTE

LuerTight fittings are designed to be used exclusively within the LuerTight family. Combining LuerTight fittings with non-LuerTight luer products may result in a poor connection.

Part No.	Description	Includes	Thru-hole	Pressure Rating	Qty.
LUERTIGHT FITTINGS SYSTEMS					
P-837	LuerTight System for 1/16" OD Tubing	(1) P-835, (1) P-836, (1) P-830T	N/A	100 psi (7 bar)	ea.
P-838	LuerTight System for 1/8" OD Tubing	(1) P-830, (1) P-831, (1) P-830T	N/A	100 psi (7 bar)	ea.
LUERTIGHT FITTING COMPONENTS					
P-830	Female Fitting for 1/8" OD Tubing	(1) Ferrule	N/A	N/A	ea.
P-830T	Set Plug to swage Ferrules into P-835 and P-830	N/A	N/A	N/A	ea.
P-831	Male Fitting for 1/8" OD Tubing	No Ferrule Required	N/A	N/A	ea.
P-835	Female Fitting for 1/16" OD Tubing	(1) Ferrule	N/A	N/A	ea.
P-836	Male Fitting for 1/16" OD Tubing	(1) Ferrule	N/A	N/A	ea.

Female = internal receiving luer pocket; Male = external luer nose (surrounded by internally-threaded locking ring)



Barbed Connectors

Our Type 1 Barbed Unions have been engineered to effectively join two pieces of soft-walled tubing together. This type of connector is typically the connector of choice for joining two peristaltic tubes with similar inner diameters together. Our unions are manufactured from either polypropylene or nylon.

Barbed to Barbed Adapters

- › Adapters on this page feature various luer to barb adaptations
- › Adapters on the next page feature a variety of barb-to-barb connectors

Use these barbed adapters to connect peristaltic-type flexible tubing for general, low pressure applications. The polypropylene used to manufacture the majority of these products is a Class VI material. Due to the low melt point of polypropylene (PP), these adapters are not autoclavable, however, they can be sterilized via gamma radiation. There are also Barb to Female Luer-Lock connectors available from ETFE, which has superior solvent resistance and a higher temperature rating (80 °C).

Barbed "Y" Adapters

Our Barbed "Y" Adapters, manufactured from polypropylene, are engineered to effectively join three pieces of soft-walled tubing together in a Y configuration, offering less turbulence and gentler mixing of fluids than a traditional Tee Connector. This type of connector works well for joining three peristaltic tubes with similar inner diameters together.

Thread to Barbed Adapters

- › Three barb sizes, for 1/16", 1/8", and 3/16" ID flexible tubing
- › Adapt to 1/4-28 flat-bottom, 5/16-24 flat-bottom, or 10-32 coned receiving ports

These adapters make it easy to connect flexible tubing to any standard 1/4-28 flat-bottom or 10-32 coned receiving port. Simply thread the adapter into a receiving port and slip tubing over the barbed stem to create a reliable low pressure connection.

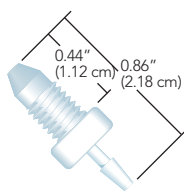

P-663
10-32 to 1/16" ID tubing

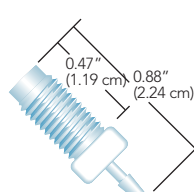

P-646
1/4-28 to 1/16" ID tubing

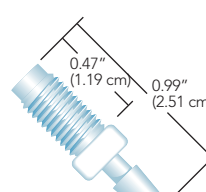

P-647
1/4-28 to 1/8" ID tubing

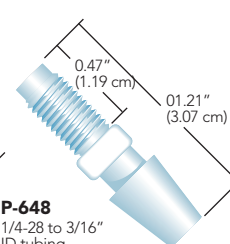

P-648
1/4-28 to 3/16" ID tubing

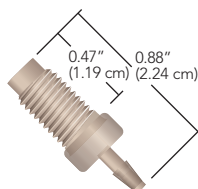

P-668
1/4-28 to 1/16" ID tubing

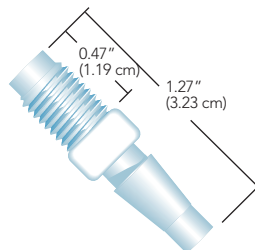

P-689
5/16-24 to 3/16" ID tubing

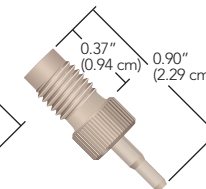

P-692
1/4-28 to 0.020"-1/32" ID tubing



Swivel Barb Adapters

- › Barb connection spins freely from the nut to prevent twist during installation
- › Manufactured from polypropylene

The Swivel Barb Adapters from IDEX Health & Science are made up of two captive pieces acting as a one-piece fitting for ease of use. Manufactured from polypropylene and available in three barb sizes, the Swivel Barb will facilitate connection between flexible tubing to a 1/4-28 flat-bottom port. The barbed insert spins freely from the threaded nut in order to prevent the tubing from twisting during installation.

RELATED PRODUCTS

- › To connect low pressure fluoropolymer tubing, try the LuerTight™ Adapters on page 89.
- › To connect peristaltic tubing to low pressure fluoropolymer tubing, see page 92.
- › For peristaltic tubing, see page 15.

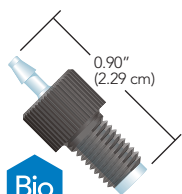

Bio

D-646
1/4-28 to 1/16" ID tubing

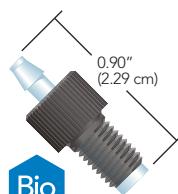

Bio

D-647
1/4-28 to 3/32" ID tubing

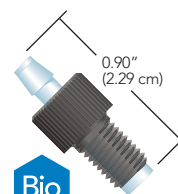

Bio

D-648
1/4-28 to 1/8" ID tubing



Luer to Barbed Adapters

Our Luer to Barbed Adapters are an excellent choice when connecting between soft-walled tubing and luer-based products, such as a syringe or a low-pressure filter, for example. We offer several different configurations, allowing you to connect various sizes of soft-walled tubing to receiving ports that accept a male luer "slip" style connection; a male luer "lock" style connection; and a female-luer style of connector.

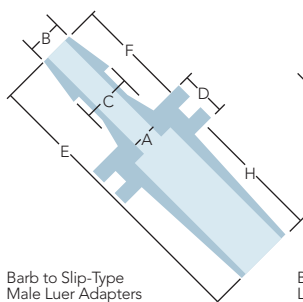

Barb to Slip-Type
Male Luer Adapters

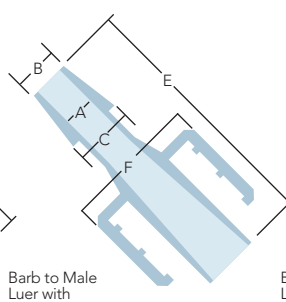

Barb to Male
Luer with
Lock Ring Adapters

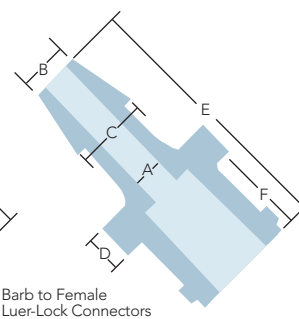

Barb to Female
Luer-Lock Connectors

Barbed Connectors (Cont.)

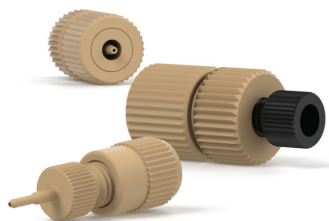

Conical Adapters

- › Direct connect 1/16" and 1/8" OD rigid and semi-rigid tubing to peristaltic tubing
- › Accept 0.020"–1/8" (0.50–3.2 mm) ID peristaltic tubing
- › Biocompatible flow path with excellent chemical compatibility

Conical Adapters provide a reliable connection between rigid/semi-rigid tubing and peristaltic-type flexible tubing, such as Tygon® and PharMed®. These adapters are composed of a PEEK polymer female nut, our Super Flangeless™ ferrule system and an ETFE or PEEK conical adapter body. The narrow coned end of the adapter body allows peristaltic tubing to slide on more easily than it does onto conventional barbed adapters. Peristaltic tubing is also easier to remove from our Conical Adapters, since no cutting or excessive pulling is required.



APPLICATION NOTE

To help secure peristaltic tubing more firmly to the Conical Adapters, simply attach a cable tie to the outside of the peristaltic tubing once it has been placed onto the Adapter body.

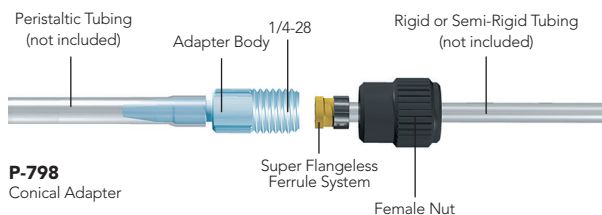
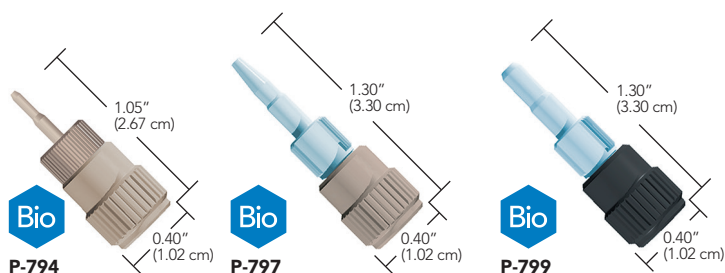

P-798
Conical Adapter

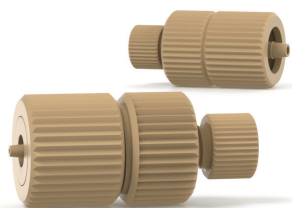

Peristaltic Tubing Adapters

These unique adapters connect peristaltic tubing to standard 1/16" or 1/8" OD tubing. A specially-designed nose allows the peristaltic tubing to simply press fit over the nose and then be held tightly in place by the retainer sleeve. Your 1/16" OD tubing may then be connected with the Flangeless Fittings supplied with the adapter. To connect your peristaltic tubing to tubing with a different OD, simply replace the supplied fittings with your choice of Flangeless Fittings from page 45.

One popular application for these adapters is to use them as "stops" for your peristaltic pump. By doing so, you can reduce the amount of peristaltic tubing required for your flow path, thus reducing cost.

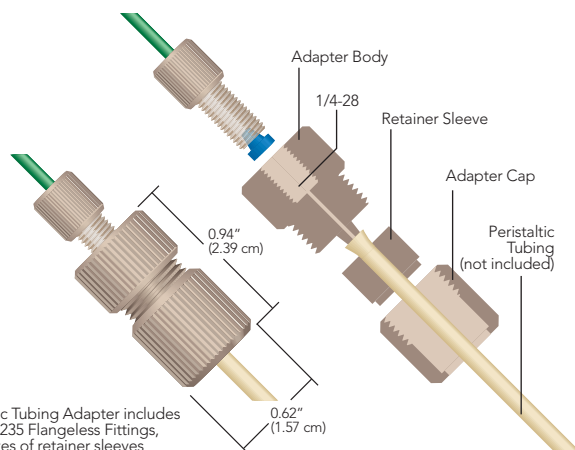

P-757
Peristaltic Tubing Adapter includes P-200/P-235 Flangeless Fittings, and 3 sizes of retainer sleeves

Barbed Connectors

Part No.	Tubing ID	Material	Qty.		
BARBED TO BARBED ADAPTERS					
P-801	0.06" (1.5 mm)	Polypropylene	ea.		
P-802	0.12" (3.0 mm)	Polypropylene	ea.		
BARBED "Y" CONNECTORS					
P-860	0.06" (1.5 mm)	Polypropylene	ea.		
P-861	0.10" (2.5 mm)	Polypropylene	ea.		
P-862	0.12" (3.0 mm)	Polypropylene	ea.		
P-863	0.18" (4.8 mm)	Polypropylene	ea.		
P-864	0.25" (6.4 mm)	Polypropylene	ea.		
THREAD TO BARBED ADAPTERS					
Part No.	Description	Material	Threads	Thru-hole	Qty.
P-663	Barb Adapter, 1/16" (1.55 mm) ID Tubing	ETFE	10-32 Coned	0.04" (1.0 mm)	ea.
P-646	Barb Adapter, 1/16" (1.55 mm) ID Tubing	ETFE	1/4-28 Flat-Bottom	0.04" (1.0 mm)	ea.
P-647	Barb Adapter, 1/8" (3.20 mm) ID Tubing	ETFE	1/4-28 Flat-Bottom	0.08" (2.0 mm)	ea.
P-648	Barb Adapter, 3/16" (4.75 mm) ID Tubing	ETFE	1/4-28 Flat-Bottom	0.10" (2.5 mm)	ea.
P-668	Barb Adapter, 1/16" (1.55 mm) ID Tubing	PEEK	1/4-28 Flat-Bottom	0.04" (1.0 mm)	ea.
P-689	Barb Adapter, 3/16" (4.75 mm) ID Tubing	ETFE	5/16-24 Flat-Bottom	0.10" (2.5 mm)	ea.
P-692	Barb Adapter, 0.020" to 1/32" (0.50 to 0.80 mm) ID Tubing	PEEK	1/4-28 Flat-Bottom	0.02" (0.5 mm)	ea.
SWIVEL BARB ADAPTERS					
D-646	Swivel Barb Adapter, 1/16" (1.55 mm) ID Tubing	Polypropylene	1/4-28 Flat-Bottom	0.03" (0.75 mm)	ea.
D-647	Swivel Barb Adapter, 3/32" (2.40 mm) ID Tubing	Polypropylene	1/4-28 Flat-Bottom	0.056" (1.5 mm)	ea.
D-648	Swivel Barb Adapter, 1/8" (3.20 mm) ID Tubing	Polypropylene	1/4-28 Flat-Bottom	0.08" (2.0 mm)	ea.
BARB TO SLIP-TYPE MALE LUER ADAPTERS					
Part No.	Description	Material	Qty.		
P-854	Male Luers (Slip-type) for use with 1/16" ID (1.55 mm) Tubing A=0.046" B=0.064" C=0.090" D=0.129" E=0.711" F=0.198" H=0.384"	PP	ea.		
<i>These slip-type male luer fittings are for use in systems for which luer lock rings are not desired.</i>					
BARB TO MALE LUER WITH LOCK RING ADAPTERS					
P-850	Male Luers with Lock Ring for use with 1/16" ID (1.55 mm) Tubing A=0.049" B=0.065" C=0.090" E=0.583" F=0.434"	PP	ea.		
P-851	Male Luers with Lock Ring for use with 3/32" ID (2.40 mm) Tubing A=0.071" B=0.100" C=0.139" E=0.681" F=0.436"	PP	ea.		
P-852	Male Luers with Lock Ring for use with 1/8" ID (3.20 mm) Tubing A=0.099" B=0.132" C=0.184" E=0.777" F=0.436"	PP	ea.		
BARB TO FEMALE LUER-LOCK CONNECTORS					
P-857	Female Luer Connectors for use with 1/16" ID (1.55 mm) Tubing A=0.030" B=0.063" C=0.106" D=0.100" E=0.598" F=0.253"	PP	ea.		
P-858	Female Luer Connectors for use with 3/32" ID (2.40 mm) Tubing A=0.056" B=0.102" C=0.145" D=0.100" E=0.648" F=0.253"	PP	ea.		
P-859	Female Luer Connectors for use with 1/8" ID (3.20 mm) Tubing A=0.080" B=0.135" C=0.187" D=0.100" E=0.733" F=0.253"	PP	ea.		
P-870	For use with 1/16" (1.55 mm) ID Tubing A=0.030" B=0.063" C=0.106" D=0.100" E=0.598" F=0.253"	ETFE	ea.		
P-872 Obsolete	For use with 1/8" (3.20 mm) ID Tubing A=0.080" B=0.137" C=0.187" D=0.100" E=0.733" F=0.253"	ETFE	ea.		
PERISTALTIC TUBING ADAPTERS					
Part No.	Description	Tubing OD	Peristaltic Tubing ID	Thru-Hole	Qty.
P-757	Standard Adapter	up to 0.180" (4.55 mm)	0.048"–0.110" (1.20–2.80 mm)	0.030" (0.75 mm)	ea.
P-767	Large Bore Adapter	up to 0.250" (6.35 mm)	0.100"–0.150" (2.55–3.80 mm)	0.070" (1.78 mm)	ea.
CONICAL ADAPTER ASSEMBLIES					
Part No.	Description	Rigid or Semi-Rigid Tubing OD	Peristaltic Tubing ID	Thru-Hole	Qty.
P-794	Conical Adapter	1/16"	0.020"–0.030" (0.50 mm–0.75 mm)	0.020" (0.50 mm)	ea.
P-797	Conical Adapter	1/16"	1/16"–3/32" (1.55 mm–2.40 mm)	0.040" (1.0 mm)	ea.
P-798	Conical Adapter	1/8"	1/16"–3/32" (1.55 mm–2.40 mm)	0.040" (1.0 mm)	ea.
P-799	Conical Adapter	1/8"	3/32"–1/8" (2.40 mm–3.20 mm)	0.060" (1.5 mm)	ea.
CONICAL ADAPTER REPLACEMENT PARTS					
Part No.	Description	For Use With	Material	Qty.	
F-156	Female Nut, 1/8", 1/4-28	P-798, P-799	Black PEEK	ea.	
P-420	Female Nut, 1/16", 1/4-28	P-794, P-797	Natural PEEK	ea.	
P-259	Super Flangeless Ferrule, 1/16"	P-794, P-797	Yellow ETFE/SST	ea.	
P-359	Super Flangeless Ferrule, 1/8"	P-798, P-799	Yellow ETFE/SST	ea.	
P-691	Conical Adapter Body	P-799	Natural ETFE	ea.	
P-692	Conical Adapter Body	P-794	Natural PEEK	ea.	