



12 FLUIDIC CONNECTIONS

114 VALVES

150 DEGASSERS

156 COLUMN HARDWARE

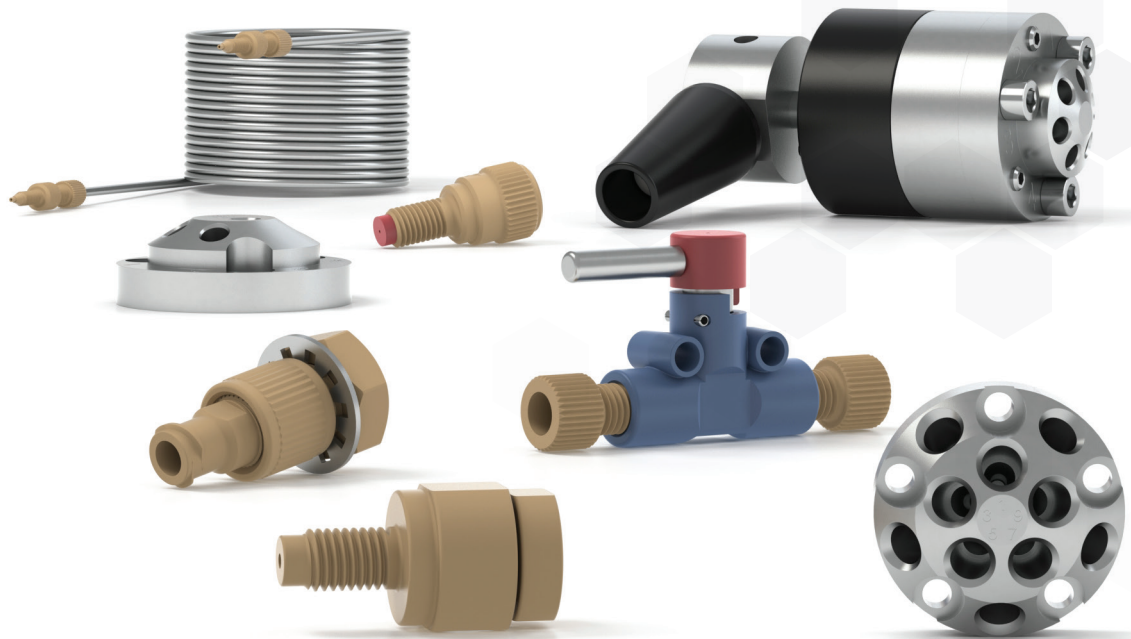

Valves

Our valves are an integral part of advanced fluid-handling solutions for a wide range of analytical instrumentation and clinical diagnostic systems. Our valve options include manual valves for lower frequency use and rotary shear valves that meet the high duty cycle requirements of UHPLC and also come in high and low pressure versions to meet your system requirements. We also offer check valves when there is a need to limit the fluid flow to one direction. Our Back Pressure Regulators products are designed to enhance system performance through outgassing prevention. All of our valve products, components, tools, and accessories are designed keeping our customer's system needs first.

115

VALVE OVERVIEW & FUNCTIONS

115

ROTARY SHEAR VALVES

119

STAND ALONE VALVE PRODUCTS

121

MANUAL VALVES

124

SPARE PARTS

126

VALVE ACCESSORIES

134

FLOW REGULATING VALVES

143

BACK PRESSURE REGULATORS

VALVE OVERVIEW & FUNCTIONS

Valve Module	Flow Configurations	Page
ACTUATED VALVES		
UP TO 15,000 PSI		119
Switching	2-Position, 6-Port 2-Position, 10-Port	
Injection	For Injection, add the appropriately sized Sample Loop to the Switching valves above	
Selection	6-Position, 7-Port	
UP TO 6,000 PSI		119
Switching	2-Position, 6-Port (Analytical and Nano Scale) 2-Position, 10-Port (Analytical and Nano Scale)	
Injection	For Injection, add the appropriately sized Sample Loop to the Switching valves above 2-Position, 6-Port (vertical port)	
Selection	6-Position, 7-Port	
UP TO 125 PSI		119
Switching	2-Position, 6-Port 2-Position, 6-Port (Double 3-Way)	
Selection	6-Position, 7-Port 10-Position, 11-Port	
MANUAL VALVES		
UP TO 9,000 PSI		123
Injection	2-Position, 6-Port (Front-Loading, 9,000 psi)	
UP TO 6,000 PSI		123
Switching	2-Position, 6-Port (Analytical and Micro Scale)	
Injection	2-Position, 6-Port	
Selection	6-Position, 7-Port	
UP TO 1,000 PSI		123
Switching	2-Way, Right Angle 4-Position, 4-Port 3-Way, T-Shape 4-Position, 4-Port 4-Way, Diagonal Flow 4-Position, 4 Port	
Injection	2-Position, 6-Port	
Selection	6-Position, 7-Port	

Rotary Shear Valves

Our Rotary Shear Valves were developed in tandem with the evolution of liquid chromatography, where combinations of elevated system pressures, aggressive chemicals, and ever-diminishing fluid volumes continually challenged system manufacturers who required highly precise fluid control and delivery. Today, many other disciplines utilize Rotary Shear Valves for their versatility, reliability, repeatability, long system uptime, and easy preventive maintenance.

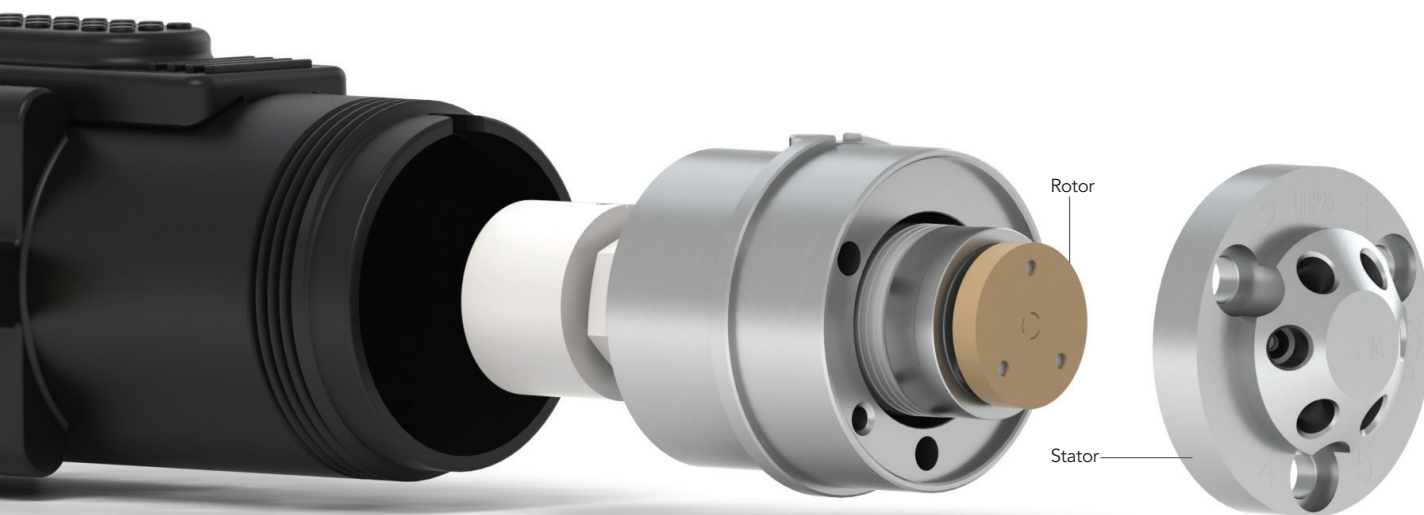

Valve Overview and Functions (Cont.)

Choosing a Rotary Shear Valve

Evaluating some simple variables will assist you in choosing the best valve for your needs.

Identify the Operating Pressure of Your Instrument or Application

Valves are designed to repeatedly deliver specific fluids to different locations in a fluidic circuit. Achieving fluidic precision at 15,000 psi requires different valve-design features than those required to achieve fluidic precision at 100 psi. A wide variety of variables such as valve architectures, metals, polymers, coatings, actuation speeds, and manufacturing techniques have been tested to achieve the fluidic accuracy and precision required for the full array of pressure conditions in life science applications. In this catalog, we define four separate pressure groupings:

Up to 15,000 psi (1,035 bar)	UHPLC/Fast Chromatography
Up to 6,000 psi (410 bar)	HPLC
Up to 1,000 psi (69 bar)	Medium Pressure Applications
Up to 125 psi (8.5 bar)	Low Pressure/ Atmospheric Pressure

Identify the Range of Flow Rates in Your System

Because Rotary Shear Valves have been used most often in chromatography systems, certain flow rate ranges have evolved functionally. However, these ranges can apply to any system, not just chromatography:

- ▶ Micro/Nano Scale — flow rates less than 100 μ L per minute
- ▶ Analytical Scale — flow rates from 100 μ L to 10 mL per minute
- ▶ Prep (or Semi-Prep) Scale — flow rates greater than 10 mL per minute

Decide What You Want the Valve to Do

In this chapter Rotary Shear Valves perform three functions:

- ▶ Switching one or more flow paths to a different destination under pressure
- ▶ Injection into a flowing stream under pressure
- ▶ Selection/distribution of a variety of system liquids by means of a common port
- ▶ Read more about valve functions on page 114.

Identify Whether You Want Automated or Manual Control

An automated valve offers more sophisticated functionality. Choose an automated valve if the application requires fast, consistent flow-stream switching. Some other advantages of automated valves include control options (PC- or instrument-triggered), higher torque operation, valve-position feedback, or very small flow paths.

Choose a manual valve if your application involves low frequency of use, demands operator control, or involves injection of smaller sample volumes. (See page 122 for more on Single Mode vs. Dual Mode operation.)

Identify the Chemical Compatibility Requirements Related to Your Fluids

Consulting the chemical compatibility chart in the Technical Resources section at the back of The IDEX Health & Science Laboratory Products catalog helps identify what valve materials to use — and avoid — in your application. You can also find Chemical Compatibility information at www.idex-hs.com under Materials and Tools.

Identify Fluidic Connection Requirements in Your System

The rotary shear valves in this catalog accommodate one or more of the following tubing outer diameters: 1/8", 1/16", or 1/32".

Effects of Valves & Tubing on Resolution

The effect of tubing on analytical and microscale analyses can be significant. Since dispersion caused by tubing is proportional to the fourth power of diameter, large bore tubing should be avoided when performing analytical scale or microscale analyses. Tubing ID size \leq 0.25 mm (0.010") is recommended.

Consider a system with injection and column switching valves and analytical columns with small-bore connecting tubing. The chromatograms below, made using a typical analytical chromatograph, show these effects. Scheme A is the control (injection valve \rightarrow column \rightarrow detector) with no valve in the system. In Schemes B and C, two model 7060 Six-Position Switching Valves were placed side by side (injection valve \rightarrow valve #1 \rightarrow column \rightarrow valve #2 \rightarrow detector).

The injection valve and detector were connected to these valves by the same tubing used in the control. The extra tubing pieces required to connect the valves to the column were a 10 cm length for valve #1-to-column, and a 35 cm length for column-to-valve #2. The diameters of these tubes are indicated in the experimental details, to the right.

Comparison of Observed Column Plates of Analytical and MicroScale Injection Valves

	7725	8125	Δ
$k' = 0.6$	2930	5054	72%
$k' = 1.5$	4653	6904	48%
$k' = 7.9$	7875	8305	5.0%

UV detector: 1 μ L volume, 4 mm path. Sample volume: 2 μ L, partial-filling method.
Column: 2 mm ID x 100 mm long, 4 μ m C-18. True plates of column = 11,570.

Effects of Valves and Tubing on Resolution

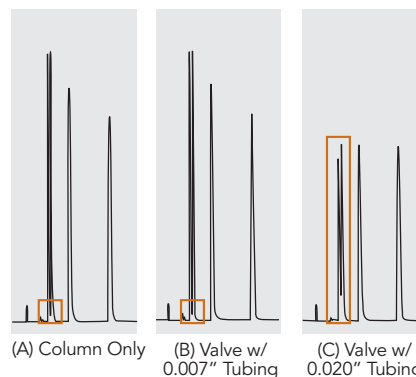

Conclusion: These sequential chromatograms show the effect of adding volume to the flow path through the addition of components.

- (A) Establishes a baseline quality of separation with the minimum volume of liquid in the flow path.
(B) Adding a valve plus smaller-ID tubing, and thereby increasing the liquid volume only marginally, barely affects the separation. However in
(C) Adding a valve plus larger-ID tubing, thereby increasing the liquid volume in the flow path to a greater degree, distinctly impairs the quality of the separation and the detectable sample.

WHAT IS MAKE-BEFORE-BREAK™, AND WHEN DOES IT MATTER?

Make-Before-Break is a unique design feature of certain dual-mode manual injection valves.

Flow paths of model 7725(i) and 9725(i) with MBB design

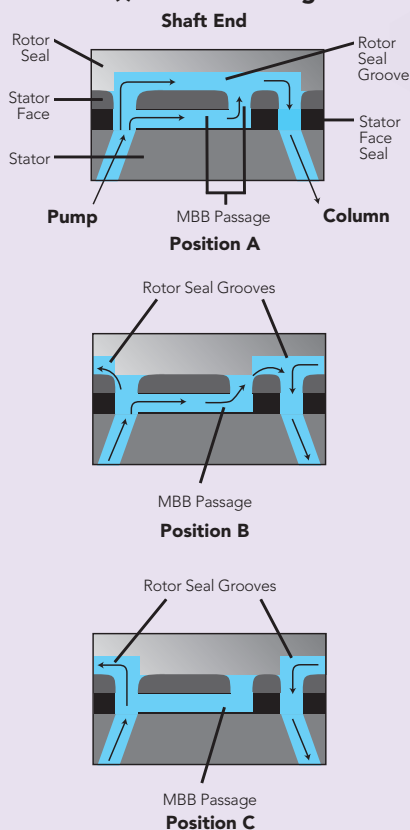

To maintain a constant, desired high-pressure flow, our Make-Before-Break (MBB®) design creates continuous flow between the LOAD and INJECT positions that virtually eliminates pressure transient shock to the system. A passage in the stator face makes a new connection before old connections break. The MBB design — an improvement over bypass-style injectors — does not dilute the sample and is easy to maintain and troubleshoot.

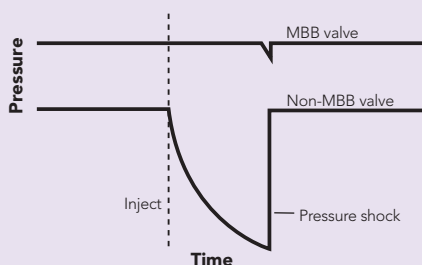

Switching Valves

Switching valves dynamically alternate between two fluid paths without manually disconnecting plumbing. In Chromatography, these valves can be used for column switching, backflushing, sample enrichment, and other techniques. In Diagnostic or Sequencing applications, the switching valve may alternate flow paths to enable back flushing or other fluidic tasks within the instrument.

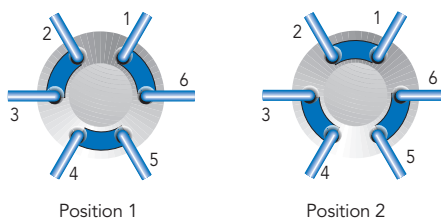

Flow path of Two-Position, Six-Port Switching Valve

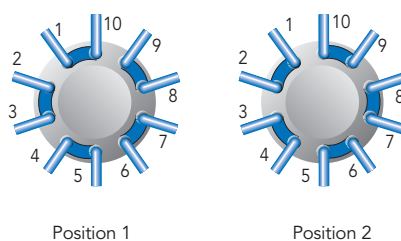

Flow path of Two-Position, Ten-Port Switching Valve

Our switching valves operate between two positions, and may have 6 or 10 ports on the face of the stator (2/6 or 2/10). The flow paths connect ports around the circumference of the stator. The manual switching valves (to 1,000 psi) described on page 123 have different flow path geometry as noted.

Injection Valves

Our injection valves are a form of switching valve. Injection valves can be automated or manual, and they are generally utilized in the two-position, six-port (2/6) configuration and have a sample loop attached.

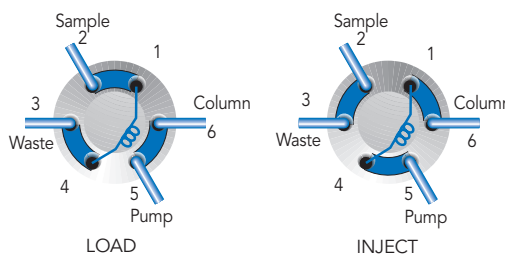

Flow path of Two-Position, Six-Port Injection Valve

The purpose of an Injection valve is to introduce a sample into a flowing stream of liquid. Some Switching valves become Injection valves by the addition of a Sample Loop (a defined length of tubing and fittings configured to match the angle of the valve ports). Sample is loaded and held in the loop until injection is triggered, either manually or automatically.

Injection valves are classified as either Single or Dual Mode based on how the Sample Loop can be filled. A Single Mode Injection valve requires complete filling of the sample loop and is configured for Rear loading, generally in an auto-sample configuration. A Dual Mode Injection valve allows either partial or complete filling of the loop, and introduces sample by syringe through the needle port built into the valve shaft. Complete filling of the sample loop in both the Dual and Single Mode Injection valves provides greater repeatability injection to injection. (See the Application Note, page 131 for greater detail on partial vs. complete loop filling.)

Valve Overview and Functions (Cont.)

Selection Valves

Selection valves enable discrete connections among multiple system liquids (mobile phase, reagents, buffers) by means of a common port (inlet or outlet) connected to a number of different reciprocal ports. In Diagnostic or Sequencing applications, the selection valve alternates between different reagents or sample streams.

Numerous configurations exist among selection valves (e.g., 6-position 7-port, or 10-position 11-port), but these valves typically operate between more than two positions. The ports are usually spaced radially, or outward in some manner around the center port of the stator.

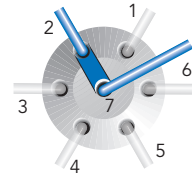

Flow path of Six-Position, Seven-Port Selector Valve



APPLICATION NOTE

Six column selection using two selection valves.

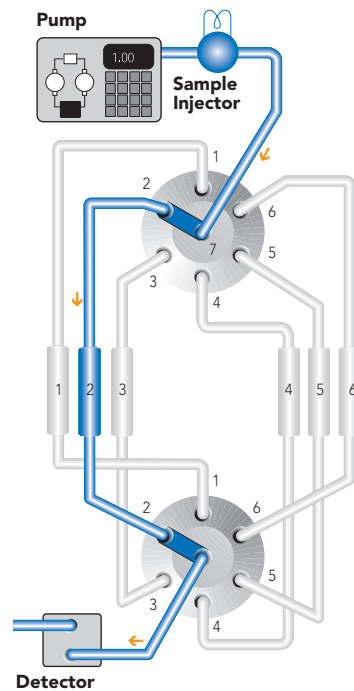



Stand Alone Valve Products

An automated valve offers more sophisticated functionality. Choose an automated valve if the application requires fast, consistent flow-stream switching. Some other advantages of automated valves include control options (PC- or instrument-triggered), higher torque operation, valve-position feedback, or very small flow paths.

MX Series II

› **MXT** to 15,000 psi
(1,035 bar)



› **MXP** to 6,000 psi
(410 bar)



› **MXX** to 125 psi
(8.5 bar)

Add our MX Series II™ actuated valves to your existing instrument or use in stand-alone lab configurations. MX valves can be controlled remotely or operated manually using the push-button front panel with LED position indicator. MX valves connect to your instrument or PC through contact closure, BCD, serial port, or USB. Commands can be sent to the MX valves using your chromatography software or the included proprietary software for timed-events programmability.

Available flow rates include options for Analytical, Micro/Nano, or Semi-Prep in a range of pressure capabilities. Valve liquid ends are available in materials chosen to be chemically inert and biocompatible. Routine maintenance using authorized RheBuild® kits (page 124) or — for the higher-pressure MXP and MXP valves — the Rapid Replacement Pods™ (page 120) assures optimal performance.

Part No.	Description	Ports, Connections	Wetted Material	Rapid Replacement Pod	Qty.
ACTUATED VALVES UP TO 15,000 PSI (1,035 BAR)					
SWITCHING					
MXT715-000	2-Position, 6-Port	10-32 Ports for 1/16" OD Tubing	UltraLife	PD715-000	ea.
MXT715-102	2-Position, 10-Port	10-32 Ports for 1/16" OD Tubing	UltraLife	PD715-102	ea.
INJECTION For Injection, add the appropriately sized Sample Loop to the Switching valves above					
SELECTION					
MXT715-105	6-Position, 7-Port	10-32 Ports for 1/16" OD Tubing	UltraLife	PD715-105	ea.
<i>All of these MXT valves include a set of 1/16" fittings. Replacement Fittings for MXT valves can be located on page 133.</i>					
ACTUATED VALVES UP TO 6,000 PSI (410 BAR)					
SWITCHING					
MXP7900-000	2-Position, 6-Port	10-32 Ports for 1/16" OD Tubing	DuraLife®	PD7900	ea.
MXP7960-000	2-Position, 10-Port	10-32 Ports for 1/16" OD Tubing	DuraLife	PD7960	ea.
MXP7980-000	Obsolete 2-Position, 6-Port, Nano, 5,000 psi (345 bar)	M4 Ports for 1/32" OD Tubing	DuraLife II	PD7980	ea.
MXP7986-000	Obsolete 2-Position, 10-Port, Nano, 5,000 psi (345 bar)	M4 Ports for 1/32" OD Tubing	DuraLife II	PD7986	ea.
MXP9900-000	2-Position, 6-Port, Biocompatible, 5,000 psi (345 bar)	10-32 Ports for 1/16" OD Tubing	PEEK	PD9900	ea.
MXP9960-000	2-Position, 10-Port, Biocompatible, 5,000 psi (345 bar)	10-32 Ports for 1/16" OD Tubing	PEEK	PD9960	ea.
INJECTION For Injection, add the appropriately sized Sample Loop to the Switching valves above					
MXP7920-000	Obsolete 2-Position, 6-Port, Vertical Port	10-32 Ports for 1/16" OD Tubing	DuraLife	PD7920	ea.
SELECTION					
MXP7970-000	Obsolete 6-Position, 7-Port	10-32 Ports for 1/16" OD Tubing	DuraLife II**	PD7970	ea.
* DuraLife is a proprietary material combination of SST and an advanced polymer.					
** DuraLife II is a proprietary material combination consisting of Titanium and an advanced polymer.					
<i>All of these MXP valves include a set of 1/16" fittings. Replacement Fittings for MXP valves can be located on page 133.</i>					
ACTUATED VALVES UP TO 125 PSI (8.5 BAR)					
SWITCHING					
MXX777-601	Obsolete 2-Position, 6-Port	Accepts Either 1/16" or 1/8" Tubing	RPC-7*	1/16" and 1/8"	ea.
MXX777-603	Obsolete 2-Position, Double Three Way	Accepts Either 1/16" or 1/8" Tubing	RPC-7	1/16" and 1/8"	ea.
MXX777-612	Obsolete 2-Position, 6-Port, Large Bore	Accepts Either 1/16" or 1/8" Tubing	RPC-7	1/16" and 1/8"	ea.
SELECTION					
MXX777-605	6-Position, 7-Port	Accepts Either 1/16" or 1/8" Tubing	RPC-7	1/16" and 1/8"	ea.
MXX777-616	Obsolete 6-Position, 7-Port, Large Bore	Accepts Either 1/16" or 1/8" Tubing	RPC-7	1/16" and 1/8"	ea.
MXX778-605	10-Position, 11-Port	Accepts Either 1/16" or 1/8" Tubing	RPC-7	1/16" and 1/8"	ea.

* RPC-7 Proprietary Polymer Combination.

All of these MXX valves include a set of 1/16" and 1/8" ferrules. Replacement Fittings for MXX valves can be located on page 133.



Rapid Replacement Pods™

For IDEX Health & Science MX Series II Valves

- › Zero downtime maintenance
- › Improves lab throughput

To help keep your instrument online and performing at maximum precision, select the exact Rapid Replacement Pod for your higher pressure MX Series II valves. Replacement pods are easily exchanged as part of scheduled preventive maintenance, or in an emergency, a pod can be substituted quickly while the original is examined and maintained at your convenience. The pod kit contains complete instructions for removal and replacement.

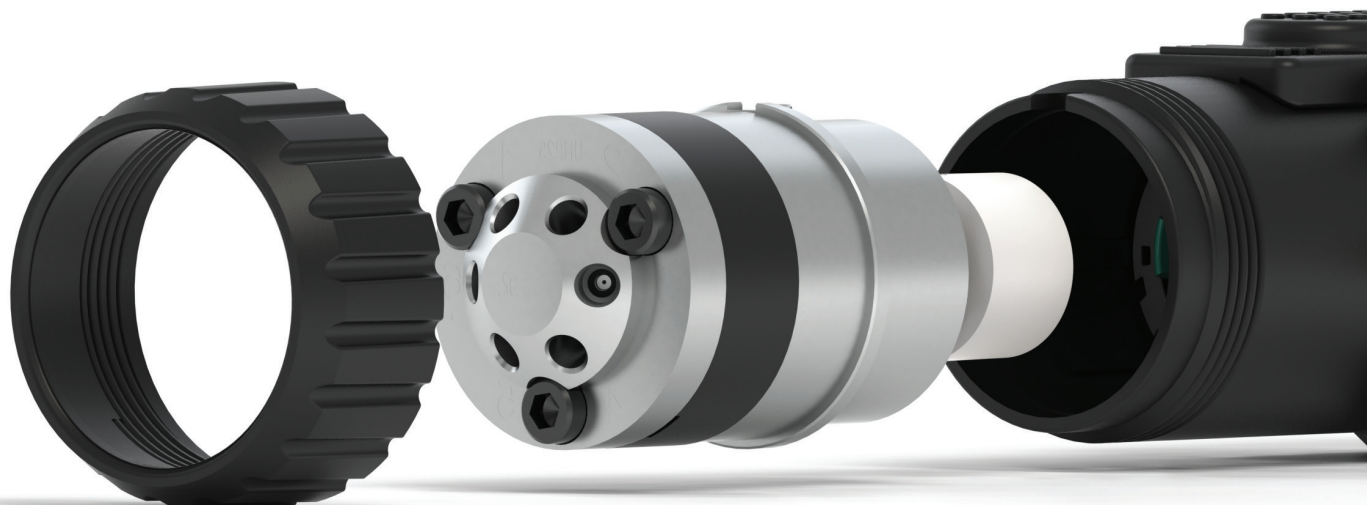

Part No.	Description	For Valve Part No.	Qty.
TO 15,000 PSI (1,035 BAR)			
SWITCHING			
PD715-000	Rapid Replacement Pod	MXT715-000	ea.
PD715-102	Rapid Replacement Pod	MXT715-102	ea.
SELECTION			
PD715-105	Rapid Replacement Pod	MXT715-105	ea.
UP TO 6,000 PSI (410 BAR)			
SWITCHING			
PD7900	Rapid Replacement Pod	MXP7900-000	ea.
PD7960	Rapid Replacement Pod	MXP7960-000	ea.
PD7980 Obsolete	Rapid Replacement Pod	MXP7980-000	ea.
PD7986 Obsolete	Rapid Replacement Pod	MXP7986-000	ea.
PD9900	Rapid Replacement Pod	MXP9900-000	ea.
PD9960	Rapid Replacement Pod	MXP9960-000	ea.
INJECTION			
PD7920 Obsolete	Rapid Replacement Pod	MXP7920-000	ea.
SELECTION			
PD7970	Rapid Replacement Pod	MXP7970-000	ea.



Manual Valves

Choose a manual valve if your application involves low frequency of use, demands operator control, or involves injection of smaller sample volumes.



7725i
Manual Injection Valve
Up to 9,000 psi (600 bar)



7060
Manual Switching Valve
Up to 7,000 psi (483 bar)



3725i-038
Manual Switching Valve
Up to 7,000 psi (483 bar)



NOTE

Manual Switching Valve Options

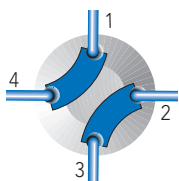

4-Way Diagonal Flow Switching Valves
(V-100D, V-101D)

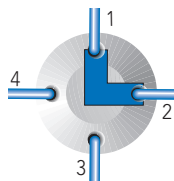

Right Angle Flow Switching Valves
(V-100L, V-101L)

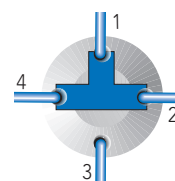

3-Way Flow Switching Valves
(V-100T, V-101T)



V-101L
Manual Switching Valve
Up to 1,000 psi (69 bar)

Manual Valves (Cont.)

APPLICATION NOTE

Switching Valve Applications

Protect sensitive system components (such as a column) during a cleaning cycle with our Diagonal Flow Switching Valve ("D"). This valve eliminates the need to remove, plug and reconnect a low pressure column (see below).

› A typical application for a Right Angle Flow Switching Valve ("L") is column switching, allowing two columns to use one detector. Detector switching is another common application for this valve (see below). Plug off the extra port with the included plug.

› Your detector switching application may require the flexibility of routing the column effluent to both detectors simultaneously while retaining the ability to isolate each detector. Use our 3-Way Flow Switching Valve ("T"), plugging off the fourth port with the included plug.

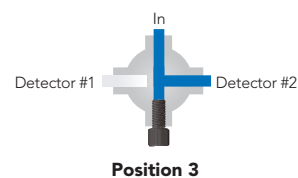
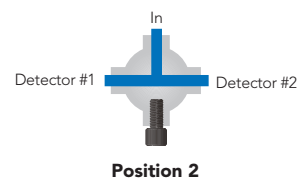
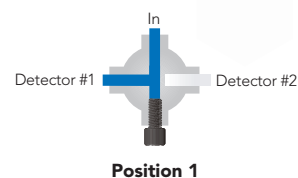
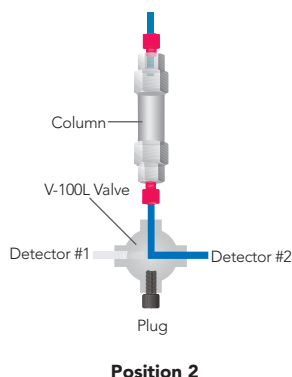
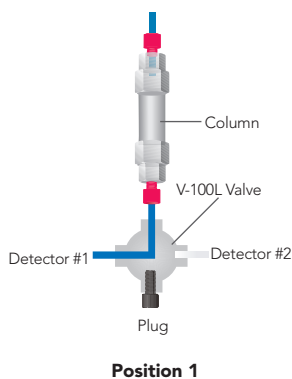
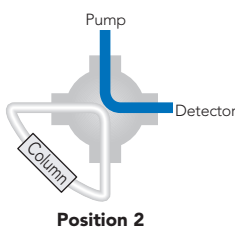
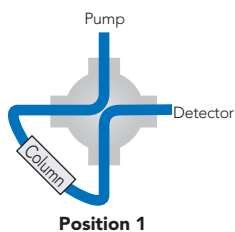

Characteristics of Manual Sample Injection Valves

Type & Capabilities	Scale	Partial Filling Volumes (Range)	Sample Loop Sizes (Range)	Wetted Materials	Max. psi (bar) ¹	Max. T (°C)	MBB ²	Model ³
Dual Mode Can load the loop by two methods: 1) Partial filling – syringe determines volume without wasting sample 2) Complete filling – loop determines volume by over filling loop	Analytical	1 µL–2.5 mL	2 µL–5.0 mL	316 SST, Vespel® PEEK, ETFE, ceramic	7,000 (483)	80°	Yes	7725, 7725i
		1 µL–5.0 mL	2 µL–10 mL		5,000 (340)	50°	Yes	9725, 9725i
	Micro	0.1 µL–500 µL	5 µL–1.0 mL	316 SST, PEEK, Vespel, ceramic	7,000 (483)	80°	No	8125
Single Mode Can load the loop by one method: Complete filling — loop determines volume by over filling loop	Preparative	100 µL–10 mL	2.0 mL–20 mL	316 SST, PEEK PEEK	5,000 (340)	50°	Yes	3725(i)-038, 3725i
					4,000 (276)	50°	Yes	
Single Mode Can load the loop by one method: Complete filling — loop determines volume by over filling loop	Analytical	Not Applicable	5 µL–5.0 mL 5 µL–10 mL	316 SST, Vespel PEEK, ETFE, Ceramic	7,000 (483)	150°	No	7010
					5,000 (340)	50°	No	9010

SST = Stainless Steel

¹ This is the maximum pressure to which the valve can be adjusted. Some models are shipped from the factory set for lower pressures.

² MBB (Make-Before-Break™) is a design that provides uninterrupted flow when switching between LOAD and INJECT. MBB also greatly reduces transient pressure shocks.

³ Models with an "i" suffix have a built-in position sensing switch. Models 8125 and 9010 also have a built-in switch.



SPECIFICATIONS & DETAILS

Part No.	Stator Passage Diameter	Factory Set Pressure	Maximum Field Set Pressure	Maximum Temperature (°C)
3000 (PEEK)	1.0 mm (0.040")	3,000 psi (207 bar)	4,000 psi (276 bar)	50°
7000, 7010 (SST)	0.6 mm (0.024")	5,000 psi (340 bar)	7,000 psi (483 bar)	150°
7000L (SST)	1.0 mm (0.040")	3,000 psi (207 bar)	5,000 psi (340 bar)	150°
7030 (SST)	0.6 mm (0.024")	5,000 psi (340 bar)	7,000 psi (483 bar)	150°
7030L (SST)	1.0 mm (0.040")	3,000 psi (207 bar)	5,000 psi (340 bar)	150°
7060 (SST)	0.4 mm (0.016")	5,000 psi (340 bar)	7,000 psi (483 bar)	80°

SST = Stainless Steel

Manual Valves

Part No.	Description	Tubing/Fitting Size	Wetted Material	Configuration	Qty.
MANUAL VALVES UP TO 9,000 PSI (600 BAR)					
INJECTION					
7725i-188	2-Position, 6-Port, 9,000 psi (600 bar)	10-32 Ports for 1/16" OD Tubing	Stainless Steel, PEEK, Ceramic	Front loading	ea.
MANUAL VALVES UP TO 6,000 PSI (410 BAR)					
SWITCHING					
3000 Obsolete	2-Position, 6-Port, Prep Scale	5/16-24 Ports for 1/8" OD Tubing	PEEK	—	ea.
7000	2-Position, 6-Port, Large Bore	10-32 Ports for 1/16" OD Tubing	Stainless Steel & Vespel®	—	ea.
7000L	2-Position, 6-Port, Large Bore	10-32 Ports for 1/16" OD Tubing	Stainless Steel & Vespel	—	ea.
7030	2-Position, 6-Port	10-32 Ports for 1/16" OD Tubing	Stainless Steel & Vespel	Double 3-Way	ea.
7030L	2-Position, 6-Port, Large Bore	10-32 Ports for 1/16" OD Tubing	Stainless Steel & Vespel	Double 3-Way	ea.
INJECTION*					
7010	2-Position, 6-Port Single Mode	10-32 Ports for 1/16" OD Tubing	Stainless Steel & Vespel	20 µL*	ea.
9010	2-Position, 6-Port Single Mode (Switching, Injection)	10-32 Ports for 1/16" OD Tubing	PEEK, ETFE, Ceramic	20 µL*	ea.
3725-038 Obsolete	2-Position, 6-Port, Prep Scale Dual Mode	5/16-24 Ports for 1/8" Tubing	Stainless Steel & PEEK	10 mL*	ea.
3725i	2-Position, 6-Port, Prep Scale Dual Mode with Switch	5/16-24 Ports for 1/8" Tubing	PEEK	10 mL*	ea.
3725i-038	2-Position, 6-Port, Prep Scale Dual Mode with Switch	5/16-24 Ports for 1/8" Tubing	Stainless Steel & PEEK	10 mL*	ea.
7725	2-Position, 6-Port, Analytical Scale Dual Mode	10-32 Ports for 1/16" OD Tubing	Stainless Steel, Ceramic, Vespel	20 µL*	ea.
7725i	2-Position, 6-Port, Analytical Scale Dual Mode with Switch	10-32 Ports for 1/16" OD Tubing	Stainless Steel, Ceramic, Vespel	20 µL*	ea.
8125**	2-Position, 6-Port, Micro Scale Dual Mode with Switch	10-32 Ports for 0.020" (0.5 mm) or 1/16" Tubing	Stainless Steel, Ceramic, Vespel	5 µL*	ea.
9725	2-Position, 6-Port, Analytical Scale Dual Mode	10-32 Ports for 1/16" OD Tubing	PEEK, ETFE, Ceramic	20 µL*	ea.
9725i	2-Position, 6-Port, Analytical Scale Dual Mode with Switch	10-32 Ports for 1/16" OD Tubing	PEEK, ETFE, Ceramic	20 µL*	ea.
SELECTION					
7060	6-Position, 7-Port	10-32 Ports for 1/16" OD Tubing	Stainless Steel & Vespel	6-Way	ea.

* Ships with a sample loop of indicated volume attached to ports 1 and 4.

** The 8125 requires special ferrules for 0.020" (0.5 mm) tubing. 8125-084-0.5 mm ferrule for 8125; 8125-086-0.5 mm ferrule for 8125 — 4-pk.

Part No.	Description	Tubing/Fitting Size	Wetted Material	Configuration	Includes	Qty.
SWITCHING						
V-100D Obsolete	4-Position, 4-Port, 500 psi (34 bar)	1/4-28 Ports for 1/16" OD Tubing	PEEK, PTFE	Double Diagonal	*	ea.
V-101D	4-Position, 4-Port, Bulkhead, 500 psi (34 bar)	1/4-28 Ports for 1/16" OD Tubing	PEEK, PTFE	Double Diagonal	*	ea.
V-100L Obsolete	4-Position, 4-Port, 500 psi (34 bar)	1/4-28 Ports for 1/16" OD Tubing	PEEK, PTFE	Right-Angle "L"	**	ea.
V-101L	4-Position, 4-Port, Bulkhead, 500 psi (34 bar)	1/4-28 Ports for 1/16" OD Tubing	PEEK, PTFE	Right-Angle "L"	**	ea.
V-100T Obsolete	4-Position, 4-Port, 500 psi (34 bar)	1/4-28 Ports for 1/16" OD Tubing	PEEK, PTFE	Single "T"	***	ea.
V-101T	4-Position, 4-Port, Bulkhead, 500 psi (34 bar)	1/4-28 Ports for 1/16" OD Tubing	PEEK, PTFE	Single "T"	***	ea.
INJECTION For Injection, add the appropriately sized Sample Loop to the Switching valves above						
V-450 Obsolete	2-Position, 6-Port, 1,000 psi (69 bar)	1/4-28 Ports for 1/16" OD Tubing	Polyimide, PTFE	Injection	(6) XP-235	ea.
V-451	2-Position, 6-Port, Bulkhead Version, 1,000 psi (69 bar)	1/4-28 Ports for 1/16" OD Tubing	Polyimide, PTFE	Injection	(6) XP-235	ea.
V-540 Obsolete	2-Position, 6-Port, 1,000 psi (69 bar)	1/4-28 Ports for 1/8" OD Tubing	Polyimide, PTFE	Injection	(6) XP-335	ea.
V-541 Obsolete	2-Position, 6-Port, Bulkhead Version, 1,000 psi (69 bar)	1/4-28 Ports for 1/8" OD Tubing	Polyimide, PTFE	Injection	(6) XP-335	ea.
SELECTION						
V-240 Obsolete	6-Position, 7-Port, 1,000 psi (69 bar)	1/4-28 Ports for 1/16" OD Tubing	Polyimide, PTFE	Multi-port Selection	(6) XP-235	ea.
V-241 Obsolete	6-Position, 7-Port, Bulkhead Version, 1,000 psi (69 bar)	1/4-28 Ports for 1/16" OD Tubing	Polyimide, PTFE	Multi-port Selection	(6) XP-235	ea.
V-340 Obsolete	6-Position, 7-Port, 1,000 psi (69 bar)	1/4-28 Ports for 1/8" OD Tubing	Polyimide, PTFE	Multi-port Selection	(6) XP-335	ea.
V-341 Obsolete	6-Position, 7-Port, Bulkhead Version, 1,000 psi (69 bar)	1/4-28 Ports for 1/8" OD Tubing	Polyimide, PTFE	Multi-port Selection	(6) XP-335	ea.

* (4) P-218BLK, (4) P-240.

** (4) P-218BLK, (4) P-240, (1) P-309.

*** (4) P-218BLK, (4) P-240, (1) P-309.

Spare Parts

We offer a full line of genuine spare parts to assist with your use of our valve products. We offer RheBuild® Kits designed for specific valve models. Rotor Seal and Stators are commonly replaceable parts.



Rotor Seals & Stators

The rotor seal is the polymeric disc that makes a high pressure seal against the stator or stator face seal. The seal wears with use and is one of the only parts that may need routine replacement.

Stators are available in 316 stainless steel, PEEK and proprietary materials. Typically, stators need replacement only if the ports or sealing surfaces become damaged. Avoid damage from use of improper injection needles by referring to the "Using Proper Syringe Needles" Application Note on page 130.

Please Note: Rotor seals for MX Series II™ Modules are available in RheBuild® Kits on this page. Stators for MX Series II Modules are available on this page. MX (Series I) Module rotor seals are available in RheBuild Kits on this page.



RheBuild® Kits

RheBuild Kits are available for most valve products. Included in each individualized RheBuild Kit are all parts, tools, and instructions to maintain precision performance of your particular product. RheBuild Kits eliminate individual part ordering.



APPLICATION NOTE

How to Select the Right Rotor Seal

The standard rotor seal in many of our manual valves is made from a Vespel® blend. This polyimide has low wear and high chemical resistance. Vespel tolerates a pH range of 0 to 10. Solutions more basic than pH 10 attack Vespel which damages the rotor seal. If you use any solutions above pH 10, our experts recommend a PEEK blend rotor seal. PEEK offers a high chemical resistance and versatility, and will tolerate the entire pH range from 0 to 14. ETFE blend rotor seals are appropriate for use in applications where PEEK is not generally acceptable, such as when methylene chloride or DMSO in higher concentrations is being used.

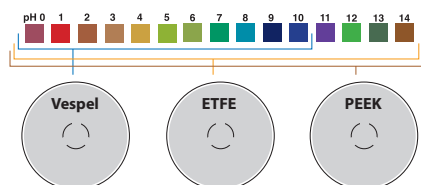

APPLICATION NOTE

How to Avoid Pressure Transients

Air in the sample loop can cause an instantaneous system pressure drop that eventually returns to a normal level. Air causes the pressure to drop when the injector moves from the LOAD to the INJECT position. When large sample loops ($\geq 100 \mu\text{L}$) are partially loaded, air present in the needle port tube is pushed into the sample loop (see Figure 1). Air can also enter the sample loop from siphoning which occurs when the vent line is higher than the injection port. In either case, upon injection, the system pressure collapses the air bubble, causing pressure to drop momentarily.

A pressure drop in the system caused by air results in changes in retention time, artifact peaks, and affects column performance.

Avoid pressure drops by removing the air in the needle port tube. Do this by flushing about 1 mL of mobile phase with a luer syringe with needle port cleaner. Keep the needle port tube filled with mobile phase by occasional flushing. Adjust the vent line(s) so the outlet is at the same horizontal level as the needle port (see Figure 2).

For additional injection troubleshooting, refer to our Troubleshooting Guide for HPLC Injection Problems. You may download the Guide from the IDEX Health & Science web site: www.idex-hs.com under Education & Tools.

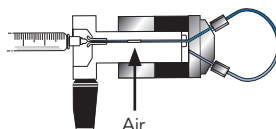

Figure 1 Air present in the needle port tube is pushed by the syringe during loading into the sample loop

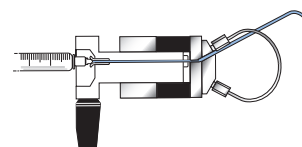
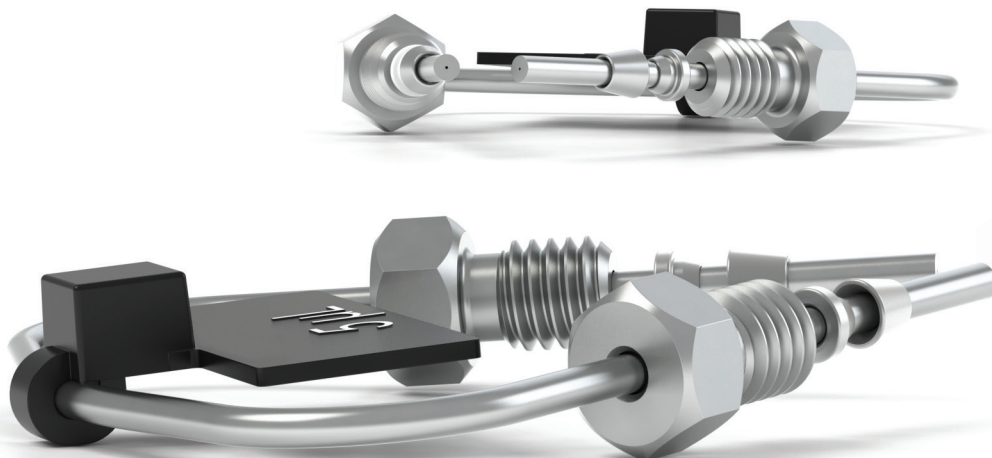

Figure 2 Pathway of the flushing mobile phase using the Needle Port Cleaner, Part # 7125-054 (see page 131) when the injector is in INJECT

Part No.	For Valve Model No.	Description	Qty.
VESPEL BLEND ROTOR SEALS			
7000-016	7000L, 7040L	Vespel Rotor Seal	ea.
7010-039	7010, 7000, 7040	Vespel Rotor Seal	ea.
7030-003	7030, 9030	Vespel Rotor Seal	ea.
7030-014	7030L	Vespel Rotor Seal	ea.
7060-070	7060, 7066	Vespel Rotor Seal	ea.
7060-064	7060L	Vespel Rotor Seal	ea.
7125-047	7125, 7725, 9725	Vespel Rotor Seal	ea.
7410-038 Obsolete	7410	Vespel Rotor Seal	ea.
7413-013 Obsolete	7413	Vespel Rotor Seal	ea.
8125-038	8125	Vespel Rotor Seal	ea.
ETFE BLEND ROTOR SEALS			
7010-071	7010, 7010-087, 7000, 7040	ETFE Rotor Seal	ea.
7030-015 Obsolete	7030, 9030	ETFE Rotor Seal	ea.
7060-074	7060, 7066, 9060	ETFE Rotor Seal	ea.
7125-079	7125, 7125-081, 7725	ETFE Rotor Seal	ea.
8125-097	8125	ETFE Rotor Seal	ea.
9010-051	9010	ETFE Rotor Seal	ea.
9125-082 Obsolete	9125, 9725	ETFE Rotor Seal	ea.
PEEK BLEND ROTOR SEALS			
3725-018	3725, 3725-038	PEEK Rotor Seal	ea.
9010-065	7000, 7010, 9010	PEEK Rotor Seal	ea.
8125-119 Obsolete	8125	PEEK Rotor Seal	ea.
9125-095	7125, 7725, 9125, 9725	PEEK Rotor Seal	ea.
STATORS FOR MX SERIES II MODULES			
7123-548	MXT715-000	Stator	ea.
7123-550	MXT715-105	Stator	ea.
7123-568	MXT715-102	Stator	ea.
7770-229	MXP7920-000	Stator	ea.
7980-004 Obsolete	MXP7980-000	Stator	ea.
7986-004 Obsolete	MXP7986-000	Stator	ea.
7900-146	MXP9900-000	Stator	ea.
7900-179	MXP7900-000	Stator	ea.
7900-183	MXP7970-000	Stator	ea.
7960-014	MXP7960-000	Stator	ea.
9960-002	MXP9960-000	Stator	ea.
STATORS FOR OTHER IDEX HEALTH & SCIENCE VALVES			
3725-006	3725, 3710-038, 3000-038 and 3030-038	Stator	ea.
7010-069	7000L, 7030L, 7040L	Stator	ea.
7010-040	7010, 7125, 7000, 7030 and 7040	Stator	ea.
7060-039	7060 and 7066	Stator	ea.
7060-065	7060L, EV501-100	Stator	ea.
7123-047	PR/EV500-100	Stator	ea.
7123-127 Obsolete	PR/EV750-107	Stator	ea.
7123-128 Obsolete	PR/EV700-107	Stator	ea.
7123-142	PR/EV500-104, EV501-104	Stator	ea.
7123-145 Obsolete	PR/EV550-104, EV551-104	Stator	ea.
7123-147 Obsolete	PR/EV550-100	Stator	ea.
7123-148 Obsolete	PR/EV500-101	Stator	ea.
7123-149 Obsolete	PR/EV550-101	Stator	ea.
7123-180	PR703-100 and EV700-105	Stator	ea.
7123-221 Obsolete	PR753-100 and EV750-105	Stator	ea.
7123-223	PR/EV700-112	Stator	ea.
7410-041 Obsolete	7410 and 7413	Stator	ea.
7520-030 (inlet) Obsolete	7520	Stator	ea.
7520-035 (outlet) Obsolete	7520	Stator	ea.
7650-002	PR/EV700-102	Stator	ea.
7725-010	7725(i)	Stator	ea.
7750-070 Obsolete	7750	Stator	ea.
7750-038	PR/EV700-100	Stator	ea.
8125-098	8125	Stator	ea.
9125-043	9125, 9010, 9030 and 9725(i)	Stator	ea.
9650-009 Obsolete	PR/EV750-102	Stator	ea.
9750-021	PR/EV750-100	Stator	ea.

Part No.	Description	Qty.
RHEBUILD KITS FOR MX SERIES II™ VALVES		
7150-999	RheBuild Kit for MXT715-000 (includes 2 rotor seals)	ea.
7152-999	RheBuild Kit for MXT715-102 (includes 2 rotor seals)	ea.
7155-999	RheBuild Kit for MXT715-105 (includes 2 rotor seals)	ea.
7920-999	RheBuild Kit for MXP7920-000 and MXP7900-000	ea.
7960-999	RheBuild Kit for MXP9960-000 (includes rotor seal and stator face seal)	ea.
7961-999	RheBuild Kit for MXP7960-000	ea.
7970-999	RheBuild Kit for MXP7970-000	ea.
79801-999 Obsolete	RheBuild Kit for MXP7980-000	ea.
79861-999 Obsolete	RheBuild Kit for MXP7986-000	ea.
7900-999	RheBuild Kit for MXP9900-000 (includes rotor seal and stator face seal)	ea.
RHEBUILD KITS FOR MANUAL VALVES		
3725-999	RheBuild Kit for models 3725, 3725i, 3725-038, 3735i-038	ea.
7010-997 Obsolete	RheBuild Kit including Stator for model 7010	ea.
7010-998 Obsolete	RheBuild Kit, pH Upgrade Kit for model 7000	ea.
7010-999	RheBuild Kit for model 7010 and 7010-type Valves	ea.
7125-999	RheBuild Kit for models 7125 and 7126	ea.
7410-999 Obsolete	RheBuild Kit for model 7410	ea.
7520-999 Obsolete	RheBuild Kit for models 7520 and 7526 (includes inlet stator and seal)	ea.
7725-999	RheBuild Kit for models 7725 and 7725i	ea.
7788-999	RheBuild Kit for model 7725i-188	ea.
8125-999	RheBuild Kit for models 8125 and 8126	ea.
9010-999	RheBuild Kit for model 9010	ea.
9125-999	RheBuild Kit for models 9125 and 9126	ea.
9725-999	RheBuild Kit for models 9725 and 9725i; 7725(i) pH upgrade kit	ea.
RHEBUILD KITS FOR MX SERIES I™ VALVES		
7900-999	RheBuild Kit for models MX7900-000, MX7925-000, MX9900-000, MX9925-000	ea.
7960-999	RheBuild Kit for model MX7960-000	ea.
7980-999 Obsolete	RheBuild Kit for model MX7980-000	ea.
7984-999 Obsolete	RheBuild Kit for model MX7984-000	ea.
7986-999 Obsolete	RheBuild Kit for model MX7986-000	ea.
RHEBUILD KITS FOR LABPRO™ & EV AUTOMATED FLUIDIC INSTRUMENTS		
1006-999	RheBuild Kit for model PR/EV100-106	ea.
5001-999 Obsolete	RheBuild Kit for models PR/EV500-101 and PR/EV550-101	ea.
5100-999	RheBuild Kit for models PR/EV500-100 and PR/EV550-100	ea.
5104-999	RheBuild Kit for models PR/EV500-104 and PR/EV550-104	ea.
7004-999 Obsolete	RheBuild Kit for models PR/EV700-104 and PR/EV750-104	ea.
7112-999	RheBuild Kit for models PR/EV700-112 and PR/EV750-112	ea.
7501-999	RheBuild Kit for models PR/EV700-100 and PR/EV750-100	ea.
7502-999	RheBuild Kit for models PR/EV700-102 and PR/EV750-102	ea.
7507-999 Obsolete	RheBuild Kit for models PR/EV700-107 and PR/EV750-107	ea.
7531-999	RheBuild Kit for models PR703-100 and PR753-100	ea.



VALVE ACCESSORIES

Our valve accessories include a variety of products that work with and are specific to our valve mechanics. From Sample Loops, driver boards, or mounting brackets we offer a wide array of accessories to meet your system requirements. We also include tools that work specifically with our valves and valve components.

- 127** STAINLESS STEEL SAMPLE LOOPS
- 128** PEEK SAMPLE LOOPS
- 131** SUCTION NEEDLE ADAPTER
- 132** INJECTION PORT ADAPTERS
- 133** WRENCHES, BRACKETS, & REPLACEMENT FITTINGS



Stainless Steel Sample Loops



APPLICATION NOTE

How to Properly Install Sample Loops: Stainless Steel

Stainless steel sample loops are supplied with fittings that are not swaged onto the tube. It is important that the loop be completely bottomed in the injector port before the ferrule is swaged onto the tube. The depth of the tubing holes may vary slightly from port to port and from valve to valve. A fitting made up in one port may leave a small cavity in another port. The cavity causes high dispersion and peak distortion such as fronting, tailing, or broadening. It is good practice to label loop ends so they will be replaced in the same, respective ports that were used in swaging the ferrules. Hint: swaging ferrules separately on each side, into each respective valve port makes loop installation easier.

To install the sample loop:

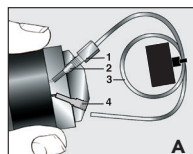

- 1 Take one end of the loop and place the nut (1) and ferrule (2) onto the tubing (3) with the threaded portion of the nut and tapered portion of the ferrule toward the end. See Figure A.

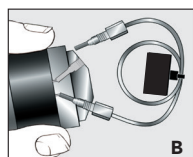

- 2 Insert the tubing into port (4). Confirm that the tubing is bottomed in the valve port as shown in Figure A.
- 3 While firmly pressing down on the tubing, hand-tighten the nut as tight as possible.

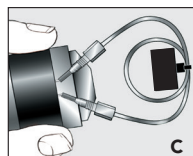

- 4 With the IDEX Wrench (page 51), designed especially for fittings, tighten one quarter turn past finger tight. Remove the loop to confirm the ferrule is swaged onto the tube.
- 5 Repeat steps a-d with the other end of the loop while the swaged end remains outside the valve port. See Figure B.
- 6 Reinstall each end of the loop to their respective ports. See Figure C.

Figure 1 Cut-away view of stainless steel sample loop installation

These high quality stainless steel sample loops have burr-free, square-cut ends to ensure a flush connection to valve ports. The size designations of loops are nominal. The actual volumes can differ from the theoretical designations because the ID tolerance varies depending on the tubing tolerance of the metal tubing bore. Accuracy of large metal loops (1.0 mm, 0.040" bore) is about $\pm 5\%$, intermediate loops (0.5 mm, 0.020" bore) $\pm 10\%$, and small loops (0.2 mm, 0.007" bore) $\pm 30\%$.

Since both standards and unknowns are usually analyzed using the same sample loop, knowledge of the actual, accurate volume is rarely needed. If the sample loop volume must be known, it is best to calibrate the loop in place on the valve so the flow passages in the valve are also taken into account. An alternative to calibration is to use a dual mode injector and partial-filling method of loading. See the "Sample Loop Loading" Application Note on page 131.

Model 7725 Injector loops are not interchangeable with loops for the model 7125. The port angle for the 7725 is 30° whereas the port angle for the 7125 is 20° requiring the loops to have a different shape. Model 8125 Micro-Scale Sample Injector requires special loops in the 5.0 μL to 50 μL range. The 8125 sample loops are made with 0.5 mm (0.020") OD tubing.

Part No.	Volume	Tubing	Qty.
STAINLESS STEEL LOOPS FOR 7125, 7010 INJECTION VALVES (DO NOT USE FOR 7725)			
7020	5 μL Sample Loop	0.18 mm (0.007") ID x 1/16" OD	ea.
7021	10 μL Sample Loop	0.30 mm (0.012") ID x 1/16" OD	ea.
7022	20 μL Sample Loop	0.51 mm (0.020") ID x 1/16" OD	ea.
7023	50 μL Sample Loop	0.51 mm (0.020") ID x 1/16" OD	ea.
7024	100 μL Sample Loop	0.51 mm (0.020") ID x 1/16" OD	ea.
7025 Obsolete	200 μL Sample Loop	0.76 mm (0.030") ID x 1/16" OD	ea.
7026	500 μL Sample Loop	0.76 mm (0.030") ID x 1/16" OD	ea.
7027	1.0 mL Sample Loop	0.76 mm (0.030") ID x 1/16" OD	ea.
7028	2.0 mL Sample Loop	1.0 mm (0.040") ID x 1/16" OD	ea.
7029	5.0 mL Sample Loop	1.0 mm (0.040") ID x 1/16" OD	ea.
1876	10 mL Sample Loop	2.0 mm (0.080") ID x 1/8" OD	ea.
STAINLESS STEEL LOOPS FOR 3725-038, 3725I-038 INJECTION VALVES			
3065-018	2.0 mL Sample Loop	2.0 mm (0.080") ID x 1/8" OD	ea.
3065-019	5.0 mL Sample Loop	2.0 mm (0.080") ID x 1/8" OD	ea.
3065-023	10 mL Sample Loop	2.0 mm (0.080") ID x 1/8" OD	ea.
3065-025	20 mL Sample Loop	2.0 mm (0.080") ID x 1/8" OD	ea.
STAINLESS STEEL LOOPS FOR 7725, 7725I, PR/EV700-100, PR/EV703-100, MX MODULE INJECTION VALVES (DO NOT USE FOR 7125)			
7755-020	5 μL Sample Loop	0.18 mm (0.007") ID x 1/16" OD	ea.
7755-021	10 μL Sample Loop	0.30 mm (0.012") ID x 1/16" OD	ea.
7755-022	20 μL Sample Loop	0.30 mm (0.012") ID x 1/16" OD	ea.
7755-023	50 μL Sample Loop	0.51 mm (0.020") ID x 1/16" OD	ea.
7755-024	100 μL Sample Loop	0.51 mm (0.020") ID x 1/16" OD	ea.
7755-025	200 μL Sample Loop	0.76 mm (0.030") ID x 1/16" OD	ea.
7755-026	500 μL Sample Loop	0.76 mm (0.030") ID x 1/16" OD	ea.
7755-027	1.0 mL Sample Loop	0.76 mm (0.030") ID x 1/16" OD	ea.
7755-028	2.0 mL Sample Loop	1.0 mm (0.040") ID x 1/16" OD	ea.
7755-029	5.0 mL Sample Loop	1.0 mm (0.040") ID x 1/16" OD	ea.
1876	10 mL Sample Loop	2.0 mm (0.080") ID x 1/8" OD	ea.
STAINLESS STEEL LOOPS FOR 8125 INJECTOR (USE 7755-024 TO 7755-029 FOR VOLUMES > 50 μL)			
8020 Obsolete	5 μL Sample Loop	0.20 mm (0.008") ID x 0.020" OD	ea.
8021	10 μL Sample Loop	0.20 mm (0.008") ID x 0.020" OD	ea.
8022 Obsolete	20 μL Sample Loop	0.25 mm (0.010") ID x 0.020" OD	ea.
8023 Obsolete	50 μL Sample Loop	0.30 mm (0.012") ID x 0.020" OD	ea.



PEEK Sample Loops

Flexible PEEK sample loops are alternatives to stainless steel loops. PEEK loop ends are provided with clean, straight cuts for easy valve installation.

PEEK polymer is inert to almost all organic solvents and is biocompatible, giving PEEK loops added versatility. Natural PEEK is used for these sample loops. Like metal loops, the size designations of PEEK loops are nominal. The actual volumes can differ from the theoretical designations because of the tolerance of the tubing bore. Accuracy of large PEEK loops (0.8 mm, 0.030" bore) is about $\pm 14\%$, intermediate loops (0.5 mm, 0.020") $\pm 21\%$, and small loops (0.2 mm, 0.007") $\pm 65\%$.

PEEK loops are also supplied with unswaged RheFlex® fittings but do not require the same swaging precaution. The fittings can reposition along the loop tubing when the fitting is reinserted in the ports for correct loop installation.



APPLICATION NOTE

Fluidic Movement in Tubes

Q: "Why can I load only up to half of the volume of the loop in partial-filling method?"

A: Sample occupies 2 μL of loop for every 1 μL loaded from the syringe. For example, 10 μL of sample spreads out over the entire length of a 20 μL loop. Any additional sample loaded will overflow the end of the loop and exit out to waste. Reproducibility is poor because the volume of sample in the loop is different from the known volume originally loaded by your syringe.

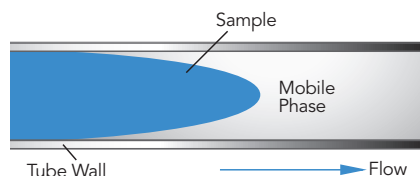

Figure 1 Schematic of sample flow through mobile phase between tubing walls

Fluid spreads in a parabolic shape through a tube instead of moving in one plug because the velocity is different at the center of the tube than at the walls. The velocity at the center of the tube is twice the average velocity, and near the wall the velocity is almost zero, creating a parabolic shape. This fluidic movement is called laminar flow. See Figure 1.

In dual mode injection valves (see "Sample Loop Loading" Application Note on page 131) the sample from the syringe needle loads directly into the sample loop. The sample volume is known since there is no sample waste. The laminar flow phenomenon accounts for the shape of the plot as shown in Figure 2. Note that the plot has three regions:

- 1 Partial-Filling Region.** When the volume dispensed is less than half the loop volume, the curve is linear. Sample has not reached the end of the loop. Within this region, performance depends on the syringe and operator.
- 2 Nonlinear Region.** When the volume dispensed is between half the loop volume and about two loop volumes, the curve is nonlinear. Sample is lost from the loop, so reproducibility is poor. If you dispense a volume equal to the loop size, you are in this region of poor performance.
- 3 Complete-Filling Region.** When the volume of sample dispensed is several loop volumes, the loop contains only pure sample, undiluted by residual mobile phase. Within this region, reproducibility is highest.

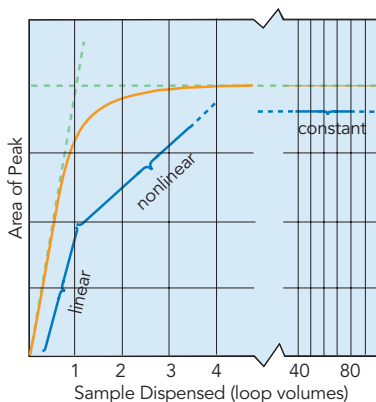

Figure 2 Sample mass (observed peak area) vs. volume of sample dispensed from the syringe, in units of loop volumes, injected onto the column from our dual mode injector such as model 7725

In the single mode injection valves the sample must pass through a connecting passage before it reaches the sample loop. Since some of the sample dispensed from the syringe remains in the connecting passageway, an unknown amount enters the sample loop. Therefore, single mode injection valves achieve high reproducibility only by using the complete-filling method.



APPLICATION NOTE

PEEK Physical Strength Characteristics

Although PEEK material is compatible with virtually all solvents, there are many factors that affect burst pressure of PEEK tubing. Factors such as increases in inner diameter, temperature, exposure time, and concentration of organic solvents affect the degradation of PEEK. Other solvents such as THF, methylene chloride and DMSO cause PEEK tubing to swell while concentrated nitric acid and sulfuric acid weaken the tubing.



APPLICATION NOTE

How to Find and Fix Common Sample Injector Leaks

Leaks cause valuable sample loss. Nobody wants that. The key to the valve holding pressure is the integrity of the sealing surfaces. If there is a scratch on the sealing surface, or the needle seal in the rotor seal is damaged, a leak may appear. It is also important to realize what appears to be a leak can instead be a result of siphoning. The following are the three most common situations in which fluid leaks occur.

- 1 If fluid leaks out of the needle port only while loading the loop (i.e., while pushing down on the plunger of the syringe), the problem is most likely that the needle seal or the needle port fitting in the loop filler port is not gripping the syringe needle tightly enough. Tighten the needle seal grip by pushing with the eraser end of a pencil on the needle port (See Figure 1). The tightening reduces the hole diameter of the needle seal and port fitting.
- 2 If fluid leaks continuously from the needle port or vent lines and/or from the stator-to-stator ring interface, replace the rotor seal and/or stator face assembly. Scratches on the rotor seal or cracks in the stator face assembly allow mobile phase to escape and cause cross port leakage. Genuine IDEX Health & Science RheBuild® Kits are listed on page 124.
- 3 If fluid leaks from the needle port and/or vent lines but eventually stops, the cause is most likely siphoning and not a leak. Siphoning occurs if the vent lines are lower or higher than the needle port. Adjust the vent line(s) so that the outlet is at the same horizontal level as the needle port to prevent siphoning. (See Figure 2).

For other leakage or injection troubleshooting, refer to our Troubleshooting Guide for HPLC Injection Problems. You may download the Guide from our web site: www.idex-hs.com under Education & Tools.

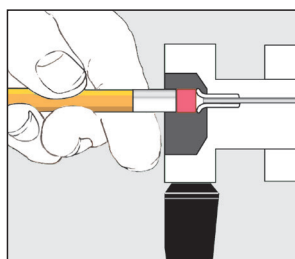

Figure 1 To reform the needle seal, push the eraser end of a pencil against the needle port

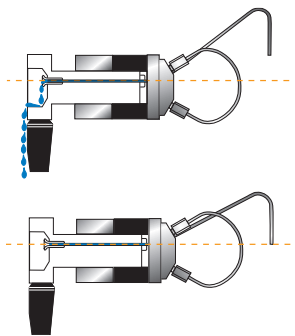

Figure 2 Needle port level compared to the level of vent line outlet:

- (A) siphoning occurs when the vent line outlet is above the needle port level
 (B) siphoning does not occur if the vent line outlet is the same horizontal level as the needle port

PEEK Sample Loops (Cont.)



APPLICATION NOTE

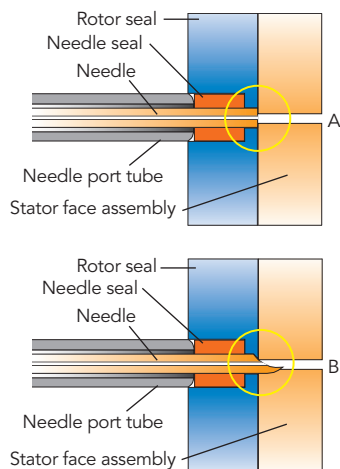

Figure 1 A square cut needle:
(A) stops against the stator face assembly; The tip of a pointed needle
(B) slips into the stator face and the tip breaks off as the valve rotates

Using Proper Syringe Needles

With front-loading injection valves it is important to use the correct needle when loading the sample loop. An incorrect needle will damage the valve and can cause poor reproducibility. When the needle is too short the tip will not reach the needle seal. When the needle is too small in diameter the seal will not grip tightly enough. Needles with a beveled tip can damage the rotor seal and stator face assembly (see Figure 1). The needle should be #22 gauge (0.028"–0.0285"/ 0.72 mm), and 90° point style (square cut end). Model 3725i requires a #16 gauge (0.0645"–0.0655"/ 1.65 mm) needle. Never use a beveled, pointed, or tapered needle.

Needle specifications are not critical when using a Loop Filler Port to load the sample loop. However, it is important to tighten the needle port fitting around the needle if using a syringe needle with a slightly smaller diameter than 0.7 mm (0.028").

If the loading method used is complete-filling, a syringe without a needle can be used. A syringe fitted with a Needle Port Cleaner can be used with a front-loading valve (Figure 2A) or with a Loop Filler Port (Figure 2B).

Needle port accessories are listed on page 132.

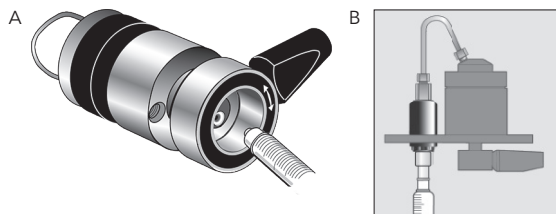
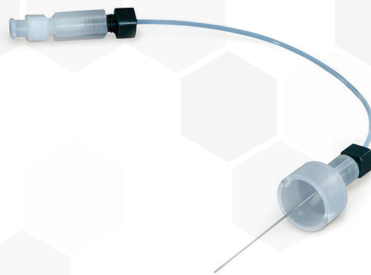

Figure 2
(A) Syringe fitted with Needle Port Cleaner (Part # 7125-054) loading a front-loading valve (model 7725);
(B) loading a Loop Filler Port (Part # 7012)

PEEK Sample Loops

Part No.	Volume	Tubing	Valco No.	Qty.
PEEK LOOPS FOR 3725, 3725I INJECTION VALVES				
3055-018	2.0 mL Sample Loop	1.6 mm (0.062") ID x 1/8" OD	N/A	ea.
3055-019	5.0 mL Sample Loop	1.6 mm (0.062") ID x 1/8" OD	N/A	ea.
3055-023	10 mL Sample Loop	2.0 mm (0.080") ID x 1/8" OD	N/A	ea.
3055-025	20 mL Sample Loop	2.0 mm (0.080") ID x 1/8" OD	N/A	ea.
PEEK LOOPS FOR 9725, 9010, PR/EV750-100, PR/EV753-100 INJECTION VALVES				
Part No.	Volume	Bore / Tubing	Valco No.	
9055-020	5.0 µL Sample Loop	0.18 mm (0.007") ID x 1/16" OD	SL5CWPK	ea.
9055-021	10 µL Sample Loop	0.25 mm (0.010") ID x 1/16" OD	SL10WPK	ea.
9055-022	20 µL Sample Loop	0.25 mm (0.010") ID x 1/16" OD	SL20WPK	ea.
9055-023	50 µL Sample Loop	0.51 mm (0.020") ID x 1/16" OD	SL50WPK	ea.
9055-024	100 µL Sample Loop	0.51 mm (0.020") ID x 1/16" OD	SL100WPK	ea.
9055-025	200 µL Sample Loop	0.51 mm (0.020") ID x 1/16" OD	N/A	ea.
9055-026	500 µL Sample Loop	0.76 mm (0.030") ID x 1/16" OD	SL500WPK	ea.
9055-027	1.0 mL Sample Loop	0.76 mm (0.030") ID x 1/16" OD	SL1KCWPK	ea.
9055-028	2.0 mL Sample Loop	0.76 mm (0.030") ID x 1/16" OD	SL2KCWPK	ea.
9055-029	5.0 mL Sample Loop	0.76 mm (0.030") ID x 1/16" OD	N/A	ea.
9055-033	Obsolete 10 mL Sample Loop	0.76 mm (0.030") ID x 1/16" OD	N/A	ea.
PEEK LOOPS FOR 7725, 7725I, PR/EV700-100				
7123-227	1 µL Sample Loop (models PR/EV700-100 and EV750-100 only)	Internal groove	N/A	ea.
7755-015	2 µL Sample Loop (models 7725, 7725i, and 9725(i) only)	Internal groove	N/A	ea.
REPLACEMENT RHEFLEX FITTINGS FOR PEEK LOOPS				
6000-078	Nut/Ferrule Set, Natural PEEK, 5/16-24, for 1/8" OD loops			ea.
6000-079	Obsolete Ferrules, Natural PEEK, for 1/8" OD loops			5-pk
6000-251	Ferrules, Natural PEEK, for 1/16" OD loops			10-pk
6000-254	Nut/Ferrule Sets, Natural PEEK, 10-32, for 1/16" OD loops			10-pk

Suction Needle Adapter



Our adaptable Loop Filler Ports (Part #7012 and 9012) are used to load sample from syringe needles or luer tips. The Needle Port (Part #9013) conserves sample by minimizing the volume between the needle and the valve.

9125-076

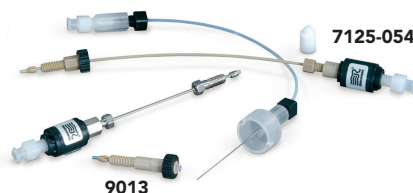

APPLICATION NOTE

Dual Mode Sample Loop Loading: Partial-Filling vs. Complete-Filling

Flow path for the typical dual mode injector

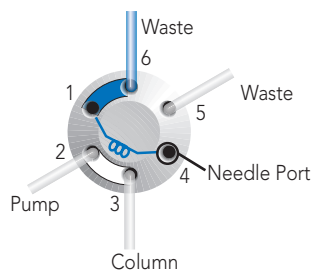

LOAD

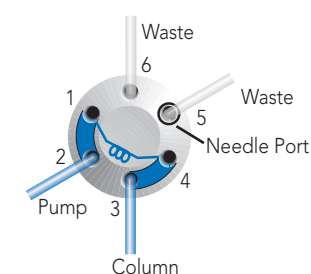

INJECT

Partial-Filling

Use the partial-filling method if you need to conserve sample, or if you want to vary sample volume frequently.

In partial-filling, the syringe sets the volume injected onto the column. There is no sample waste, and the volume injected onto the column is equal to that dispensed from the syringe. Reproducibility is 1.0% relative standard deviation (RSD). The volume of the sample loaded is limited to half the sample loop volume. For example, the most you can load into a 200 μL sample loop is 100 μL .

Complete-Filling

Use the complete-filling method if you have plenty of sample, if you do not vary sample volume, or if you need high reproducibility.

In complete-filling, the loop sets the volume loaded onto the column. Use excess sample (two to five loop volumes) to replace all the mobile phase in the loop. See Figure 2. Change the loop to vary the sample volume. Reproducibility is typically 0.1% RSD for loop sizes $\geq 5 \mu\text{L}$. Accuracy is limited as loop volumes are nominal.

Q: "Which method should I use and which IDEX Health & Science sample injection valves use this method?"

A: There are two types of injection valves available: dual mode and single mode. Dual mode injection valves allow both partial- and complete-filling whereas single mode injection valves allow only complete-filling. See manual injection valves, page 123.

If you are collecting experimental data, sample is scarce, and/or you want to use different sample volumes, a dual mode injector with a large volume sample loop is appropriate. Only dual mode injection valves allow the partial-filling method for easily varying your volumes (up to half your sample loop volume) by setting the syringe volume. Once you begin routine analysis, and/or you have an abundance of sample, either a dual mode or single mode injector is appropriate. Both types of injection valves allow the complete-filling method in which you overflow the sample loop. Complete-filling maximizes the reproducibility of your results.

Part No.	Description	Qty.
SUCTION NEEDLE ADAPTER & ACCESSORIES		
7012 Obsolete	Stainless Steel Loop Filler Port	ea.
7125-054	Needle Port Cleaner	ea.
9012 Obsolete	PEEK Loop Filler Port	ea.
9013	PEEK Needle Port	ea.
9125-076	Suction Needle Adapter (for Models 7725 and 9725)	ea.

Wrenches, Brackets, & Replacement Fittings



6810

Valve Wrenches

- › For convenient wrench-tightening of fittings on high pressure rotary shear valves
- › For removal of knobs on Manual Valves

The smartly designed IDEX Wrench is a double-ended slotted socket wrench that fits over 1/16" and 1/8" OD tubing. It easily loosens and tightens 1/4" and 5/16" hex head stainless steel or PEEK fittings. The "Z" shape of the IDEX Wrench provides ideal leverage for changing sample loops and fittings, and keeps one end from restricting the use of the other.

The V-103 is an Allen (hex-key) wrench designed to remove the knob from our V-101 valves (page 123). The V-104 is an Allen wrench that can be used to remove the knob from our Medium Pressure Selection and Injection Valves (also found on page 123).

Mounting Brackets

Our mounting brackets and panels of different shapes and sizes organize and provide a sturdy support for IDEX Health & Science valves. The Ring Stand Mounting Bracket now allows the valves to mount onto common laboratory equipment.



7160-029



MXX Replacement Fittings

Use these replacement Ferrules and O-rings for 1/8" and 1/16" tubing with the MXX Series II valves shown on page 119. Please see the part number chart below for a list of individual part numbers.

Part No.	Description	Qty.
VALVE WRENCHES		
6810	IDEX Wrench	ea.
MOUNTING BRACKET ACCESSORIES		
7160 Obsolete	Mounting Panel	ea.
7160-010 Obsolete	Valve Angle Bracket	ea.
7160-029	Ring Stand Mounting Bracket	ea.
VALVE BRACKET		
M-615-1 Obsolete	Mounting Bracket for IDEX Health & Science Switching Valves	ea.
M-615-2 Obsolete	Mounting Bracket for IDEX Health & Science Injection and Selection Valves	ea.
REPLACEMENT FITTINGS		
7770-039	Ferrules for 1/8" OD Tubing	25-pk
7770-040 Obsolete	Ferrules for 1/8" Tubing	50-pk
7770-044	Ferrules for 1/16" OD Tubing	25-pk
7770-124	O-rings for 1/16" OD Tubing	25-pk

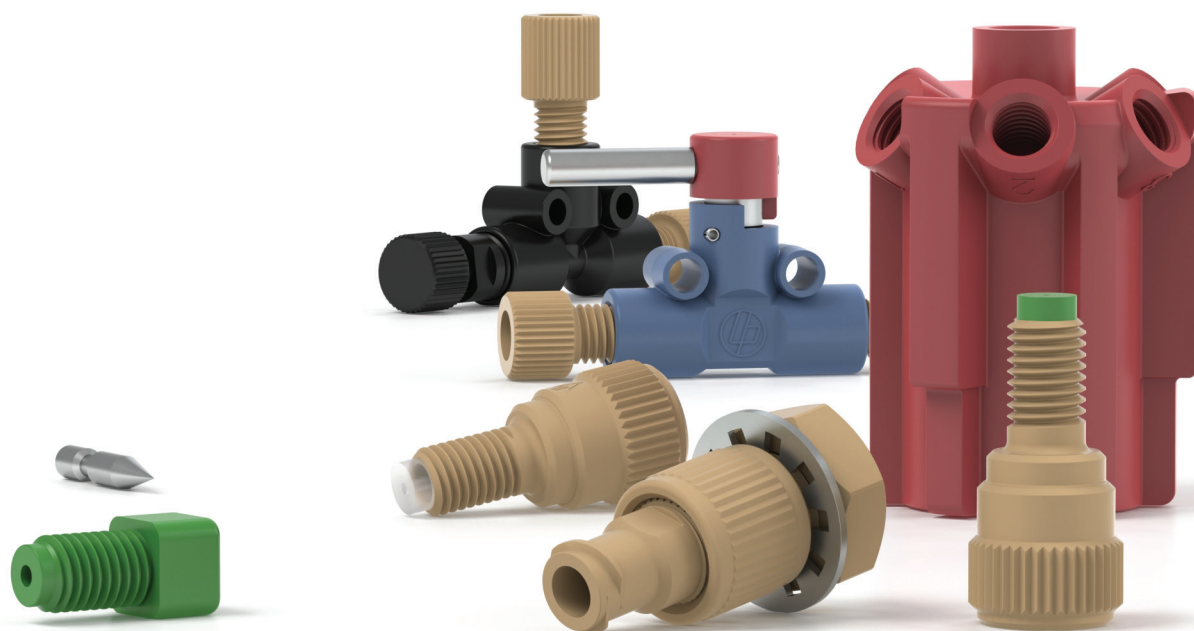

FLOW REGULATING VALVES

Our Flow Regulating Valves include specifically designed valves that are used to control or stop the flow of a stream and are ideal for use if your application involves low frequency of use or demands operator control. A variety of types and styles of valves allow you to manage directional flow. In addition, we offer replacement cartridges for all of our flow regulating valves.

- 135** CHECK VALVES
- 140** MICRO-SPLITTER VALVES
- 141** MICRO-METERING VALVES
- 142** SHUT-OFF VALVES

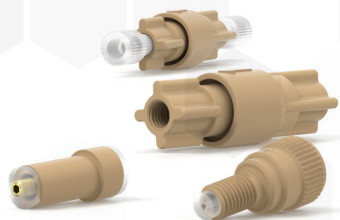

Inline Cartridge Check Valves

- › Low cracking pressures
- › Less than 150 μL internal volume
- › **Materials of construction:**
PEEK; perfluoroelastomer (CV-3001);
gold-plated stainless steel spring
(CV-3001); ethylene propylene (CV-3011);
and stainless steel spring (CV-3011)

Our cartridge-style Inline Check Valves are designed to limit flow to one direction. These assemblies withstand system pressures of 1,000 psi (69 bar). The cracking pressures for the Inline Check Valve Cartridges are 1.5 psi (0.1 bar) for the CV-3001 and 3 psi (0.2 bar) for the CV-3011. Tolerance on the cracking pressure for CV-3001 is ± 0.5 psi (0.03 bar) and ± 1.5 psi (0.1 bar) on CV-3011.

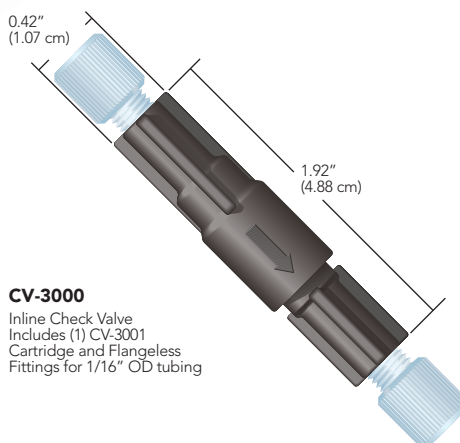

Part No.	Description	Includes	Swept Volume	Qty.
INLINE CARTRIDGE CHECK VALVES				
CV-3000	Inline Check Valve Assembly for 1/16" OD tubing	(1) CV-3001, (2) XP-215	96 μL	ea.
CV-3001	Inline Check Valve Cartridge for CV-3000		91 μL	ea.
CV-3010	Inline Check Valve Assembly for 1/8" OD tubing	(1) CV-3011, (2) XP-315	100 μL	ea.

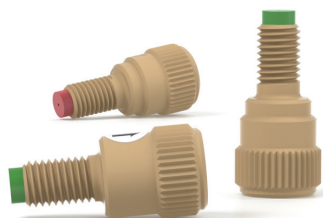

Standard 1/4-28 Inline Check Valves

- › Add back-flow protection to any 1/4-28 flat-bottom port
- › 15 psi (1 bar) and 3 psi (0.2 bar) cracking pressure versions
- › Excellent chemical resistance

› Materials of construction:

PEEK; PCTFE; perfluoroelastomer; PTFE (CV-3301 and CV-3302); stainless steel (CV-3301 and CV-3302); or gold-plated stainless steel (CV-3315 and CV-3316)

Connect these Inline Check Valves to any 1/4-28 flat-bottom port. Then thread your 1/4-28 flat-bottom fitting into the check valve to connect the tubing. Once installed, the spring-actuated sealing system eliminates back flow, helping to prevent upstream contamination or damage. In addition, the unique design of this product eliminates the additional tubing cuts and connections required to install conventional inline check valves.

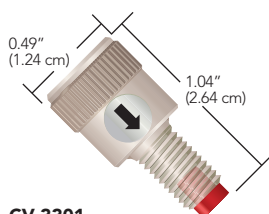

CV-3301
Standard, Inlet
1/4-28 FB Male to 1/4-28 FB Female
15 psi (1 bar) cracking pressure

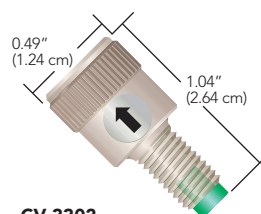

CV-3302
Standard, Outlet
1/4-28 FB Male to 1/4-28 FB Female
15 psi (1 bar) cracking pressure

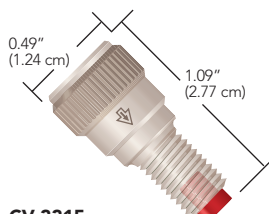

CV-3315
Standard, Inlet
1/4-28 FB Male to 1/4-28 FB Female
3 psi (0.2 bar) cracking pressure



CV-3316
Standard, Outlet
1/4-28 FB Male to 1/4-28 FB Female
3 psi (0.2 bar) cracking pressure



RELATED PRODUCTS

- › 1/4-28 Inline Check Valves and Non-Metallic Check Valves with 1/4-28 flat-bottom ports (next page) can be used with any 1/4-28 Flangeless, Super Flangeless™, and VacuTight™ fitting on pages 45, 39, and 42, respectively, of the Fittings Chapter.
- › Micro-Volume Inline Check Valves and Non-Metallic Check Valves with 10-32 coned ports (next page) can be used with any 10-32 polymer Fingertight or SealTight™ fitting on page 36. Connect capillary tubing using the optional ferrules listed on page 35 or the NanoTight™ Fittings and Tubing Sleeves on page 37.

Part No.	Description	Cracking Pressure	Qty.
STANDARD 1/4-28 INLINE CHECK VALVES			
CV-3301	Inlet Check Valve, 1/4-28 FB, M to 1/4-28 FB, F*	15 psi (1 bar)	ea.
CV-3302	Outlet Check Valve, 1/4-28 FB, M to 1/4-28 FB, F*	15 psi (1 bar)	ea.
CV-3315	Inlet Check Valve, 1/4-28 FB, M to 1/4-28 FB, F*	3 psi (0.2 bar)	ea.
CV-3316	Outlet Check Valve, 1/4-28 FB, M to 1/4-28 FB, F*	3 psi (0.2 bar)	ea.

* M = Male (external) threads; F = Female (internal) threads; C = Coned; FB = Flat-Bottom



Non-Metallic Check Valves

- › Cracking pressure of 8 psi (0.6 bar)
- › Excellent chemical resistance
- › **Materials of construction:**
PEEK and perfluoroelastomer, suitable for biological applications

Our Non-Metallic Check Valves are biocompatible and delivers a low cracking pressure. With a swept volume of only 7.4 μL , our Check Valve is perfect for applications where low flow path volume is critical, such as delivery to lab-on-a-chip, single-cell analysis and micro- or nano-LC post-column derivatization. Once installed, this check valve helps prevent back flow and the potential for contamination or damage to sensitive upstream equipment.

10-32 Micro-Volume Inline Check Valves

With a swept volume of only 7.4 μL , our 10-32 Micro-Volume Inline Check Valves are perfect for applications where low flow path volume is critical, such as delivery to lab-on-a-chip, single-cell analysis and micro- or nano-LC post-column derivatization. Once installed, this check valve helps prevent back flow and the potential for contamination or damage to sensitive upstream equipment.

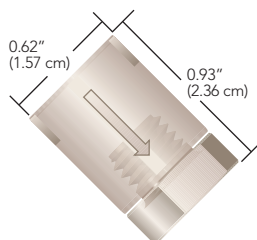

CV-3500
Micro-Volume Inline
10-32 C Female to 10-32 C Female

NOTE

Check valves are specified by:

- › **Cracking Pressure:** the pressure required for the valve to open in the direction of the arrow.
- › **Maximum Pressure:** the maximum pressure the valve can experience in the reverse direction without leaking backwards.
- › **Back Pressure Created:** the amount of back pressure generated by the check valve with 50 mL/min room temperature water flowing in the direction of the arrow.

SPECIFICATIONS & DETAILS

	Swept Volume	Thru-Hole	Max. Pressure Rating	Back Pressure Created	Cracking Pressure Tolerance
STANDARD 1/4-28 FB					
CV-3301, CV-3302	20 μL	0.020" (0.50 mm)	2,000 psi (138 bar)	45 psi (3.1 bar)	± 5 psi (0.34 bar)
CV-3315, CV-3316	16 μL	0.020" (0.50 mm)	2,000 psi (138 bar)	10 psi (0.7 bar)	± 1.5 psi (0.10 bar)
NONMETALLIC 10-32 CONED MICRO-VOLUME					
CV-3500	7.4 μL	0.010" (0.25 mm)	3,000 psi (207 bar)	25 psi (1.7 bar)	± 5 psi (0.34 bar)

10-32 Micro-Volume Inline Check Valves

Part No.	Description	Cracking Pressure	Qty.
NONMETALLIC 10-32 MICRO-VOLUME INLINE CHECK VALVE			
CV-3500	Inlet/Outlet Check Valve, 10-32 C, F to 10-32 C, F*	8 psi (0.6 bar)	ea.

* M = Male (external) threads; F = Female (internal) threads; C = Coned; FB = Flat-Bottom

Non-Metallic Check Valves (Cont.)

- › Low cracking pressure of 1 psi (0.07 bar)
- › Multiple configurations for different applications
- › Excellent chemical resistance
- › **Materials of construction:**
PEEK and perfluoroelastomer

1/4-28 & 10-32 Inline Check Valves

Our 1/4-28 & 10-32 Non-Metallic Inline Check Valves provide excellent backflow protection for sensitive equipment along with outstanding chemical resistance guaranteed by the PEEK polymer and perfluoroelastomer construction. Metal-free composition makes these check valves perfect for use with corrosive fluids or biological samples.

These check valves function well up to moderately-high pressure applications. Low internal volume also allows them to be used in areas where flow path volume is important; however, higher flow rates can pass through with minimal pressure drop.

APPLICATION NOTE

- › The CV-3320 or CV-3321 style can be connected to any 1/4-28 flat-bottom port for trouble-free back flow protection.
- › When using a pump after the analytical column, consider placing a CV-3330 Check Valve after the column to prevent fluid from the post-column pump from flowing backwards through the column. This product also serves as an excellent nonmetallic alternative to our CV-3010 (page 135) in sparging applications where the mobile phase may be corrosive to the stainless steel or ethylene propylene components inside the CV-3010 assembly.
- › The CV-3335 Inlet and CV-3336 Outlet Check Valves allow tubing larger than 1/16" OD (up to 1/8") to be connected into a 10-32 coned internal port. Use both of these check valves when attaching a larger-volume sample loop to an analytical-scale injection valve. This setup limits the flow of the sample into the loop to one direction, minimizing back flow and sample carry-over.
- › The CV-3340 is useful in virtually any high pressure fluid pathway using 1/16" or smaller OD tubing, where limiting the direction of flow is desirable.

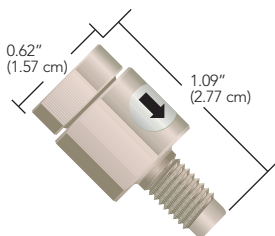

CV-3320, CV-3322, CV-3324
Nonmetallic, Inlet
1/4-28 FB Male to 1/4-28 FB Female

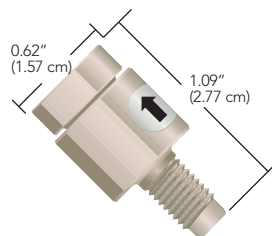

CV-3321, CV-3323, CV-3325
Nonmetallic, Outlet
1/4-28 FB Male to 1/4-28 FB Female

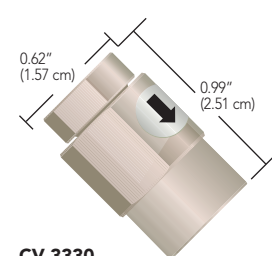

CV-3330
Nonmetallic, Inline
1/4-28 FB Female to 1/4-28 FB Female

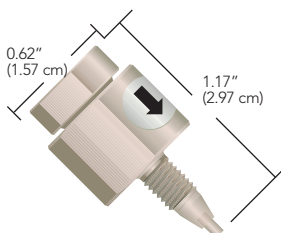

CV-3335
Nonmetallic, Inlet
1/4-28 FB Female to 10-32 C Male

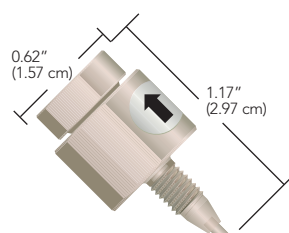

CV-3336
Nonmetallic, Outlet
1/4-28 FB Female to 10-32 C Male

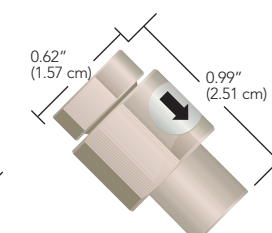

CV-3340
Nonmetallic, Inline
10-32 C Female to 10-32 C Female

SPECIFICATIONS & DETAILS

	Swept Volume	Max. Pressure Rating	Back Pressure Created	Cracking Pressure Tolerance
CV-3320, CV-3321	37 µL	2,000 psi (138 bar)	30 psi (2.1 bar)	± 0.5 psi (0.03 bar)
CV-3330	34 µL	2,000 psi (138 bar)	30 psi (2.1 bar)	± 0.5 psi (0.03 bar)
CV-3335, CV-3336	49 µL	2,000 psi (138 bar)	30 psi (2.1 bar)	± 0.5 psi (0.03 bar)
CV-3340	34 µL	2,000 psi (138 bar)	30 psi (2.1 bar)	± 0.5 psi (0.03 bar)
CV-3322, CV-3323	49 µL	2,000 psi (138 bar)	30 psi (2.1 bar)	± 0.5 psi (0.03 bar)
CV-3324, CV-3325	182 µL	2,000 psi (138 bar)	30 psi (2.1 bar)	± 0.5 psi (0.03 bar)

NOTE

Upon initial use — or following a period of extended inactivity — the cracking pressure for these check valves may be somewhat higher than the stated cracking pressure.

1/4-28 & 10-32 Inline Check Valves

Part No.	Description	Cracking Pressure	Thru-Hole	Qty.
NONMETALLIC 1/4-28 AND 10-32 INLINE CHECK VALVES				
CV-3320	Inlet Check Valve, 1/4-28 FB, M to 1/4-28 FB, F*	1 psi (0.07 bar)	0.020" (0.50 mm)	ea.
CV-3321	Outlet Check Valve, 1/4-28 FB, M to 1/4-28 FB, F*	1 psi (0.07 bar)	0.020" (0.50 mm)	ea.
CV-3322	Inlet Check Valve, 1/4-28 FB, M to 1/4-28 FB, F*	1 psi (0.07 bar)	0.040" (1.0 mm)	ea.
CV-3323	Outlet Check Valve, 1/4-28 FB, M to 1/4-28 FB, F*	1 psi (0.07 bar)	0.040" (1.0 mm)	ea.
CV-3324	Inlet Check Valve, 1/4-28 FB, M to 1/4-28 FB, F*	1 psi (0.07 bar)	0.060" (1.60 mm)	ea.
CV-3325	Outlet Check Valve, 1/4-28 FB, M to 1/4-28 FB, F*	1 psi (0.07 bar)	0.060" (1.60 mm)	ea.
CV-3330	Inlet/Outlet Check Valve, 1/4-28 FB, F to 1/4-28 FB, F*	1 psi (0.07 bar)	0.020" (0.50 mm)	ea.
CV-3335	Inlet Check Valve, 1/4-28 FB, F to 10-32 C, M*	1 psi (0.07 bar)	0.020" (0.50 mm)	ea.
CV-3336	Outlet Check Valve, 1/4-28 FB, F to 10-32 C, M*	1 psi (0.07 bar)	0.020" (0.50 mm)	ea.
CV-3340	Inlet/Outlet Check Valve, 10-32 C, F to 10-32 C, F*	1 psi (0.07 bar)	0.020" (0.50 mm)	ea.

* M = Male (external) threads; F = Female (internal) threads; C = Coned; FB = Flat-Bottom



Quick-Stop Luer Inline Check Valve

- › Check valve protection with luer convenience
- › Remains open when engaged
- › **Materials of construction:** PEEK, perfluoroelastomer, and gold-plated stainless steel spring

The Quick-Stop Luer Check Valve is designed to provide inline luer connect/disconnect convenience without the mess and hazard of spills. Just connect the valve assembly to your inline tubing using standard 1/4-28 flat-bottom fittings (see pages 39 – 46). The check valve is automatically opened once the luer connection is engaged, allowing flow in either direction. Disconnecting the luer union causes the check valve to close. Please see the “Application Note” on this page for specific ideas regarding use of this valve.



RELATED PRODUCTS

- › 1/4-28 Inline Check Valves and Non-Metallic Check Valves with 1/4-28 flat-bottom ports (next page) can be used with any 1/4-28 Flangeless, Super Flangeless™, and VacuTight™ fitting on pages 45, 39, and 42, respectively, of the Fittings Chapter.
- › Micro-Volume Inline Check Valves and Non-Metallic Check Valves with 10-32 coned ports (page 137) can be used with any 10-32 polymer Fingertight or SealTight™ fitting on page 36. Connect capillary tubing using the optional ferrules listed on page 35 or the NanoTight™ Fittings and Tubing Sleeves on page 37.



APPLICATION NOTE

Inlet Solvent Reservoir:

Quickly change your solvent on the low pressure end of an HPLC system, while preventing potentially hazardous spills! Just install a Quick-Stop Luer Check Valve Assembly between your solvent reservoir and the pump, with the valve towards the bottle. The valve will prevent solvent leakage from the line coming from the reservoir, while the check valves in your pump prevent spills from the line leading to the pump. With both lines still full of solvent, this system also helps reduce the need to reprime your pump.

FIA Sample Injection:

The Quick-Stop Luer Check Valve provides a practical means to introduce a sample into FIA and other low pressure systems, when used in conjunction with a P-612 Pressure Relief Valve Tee (page 148). Simply connect the Tee into the appropriate flow path line with the included fittings and thread the P-697 Quick-Stop Luer Valve onto the 1/4-28 male end of the Tee. Sample can then be introduced conveniently by using a standard luer-tipped syringe. The check valve is automatically opened when the syringe is attached and closed when the syringe is removed.

Post Column Derivatization:

For post-column derivatization, place a CV-3000 Inline Check Valve on the effluent side of your column to prevent derivatizing agents from flowing backwards and poisoning the column. Placement on the post-column reagent line will also prevent mobile phase from contaminating the reagent if the auxiliary pump fails.

Helium Sparging Tank Protection:

Try the CV-3010 Assembly, designed specifically for degassing (sparging) lines to prevent solvent backup if the sparging gas runs out. This check valve will help prevent potential solvent cross-contamination and damage to the gas regulating valve.

Part No.	Description	Includes	Swept Volume	Qty.
QUICK-STOP LUER CHECK VALVE				
P-696	Quick-Stop Luer Check Valve Assembly	(1) P-697, (1) P-655	127 µL	ea.
P-697	Quick-Stop Luer Check Valve		107 µL	ea.
P-699	Bulkhead Quick-Stop Luer Valve	(1) nut/lock washer set	107 µL	ea.



Micro-Splitter Valves

- › For interfacing LC-MS systems
- › Adjustable split stream flow rates
- › Versions for up to 800 psi (55 bar) and up to 4,000 psi (276 bar)



APPLICATION NOTE

- › With an incoming flow rate of 1 mL/min using room temperature water and equal pressures on both outlet lines, the minimum split flow rate is 2 μ L/min for the standard micro-splitter valves and 4.8 μ L/min for the high pressure micro-splitter valves.
- › All Micro-Splitter Valves have been tested at flow rates to 100 mL/min, with a maximum resulting pressure drop of only 45 psi (3.1 bar) when the valve is fully opened.

Our Micro-Splitter Valves are designed to accurately split and control a low-flow stream off a single incoming supply.

Choose between 1/4-28 flat-bottom and 10-32 coned threaded versions.

The High Pressure Micro-Splitter Valves are designed to operate successfully up to 4,000 psi (276 bar) and the standard Micro-Splitter valves are pressure rated to 800 psi (55 bar).

The Graduated Valve offers many of the benefits and features of Micro-Splitter Valves, plus the ability to adjust and set the split flow to repeatable settings. This allows documentation of settings and the resulting flow rates for easier method development. The graduations also make it easier to employ the valve in a system used to run multiple analyses that require different split flow rates.

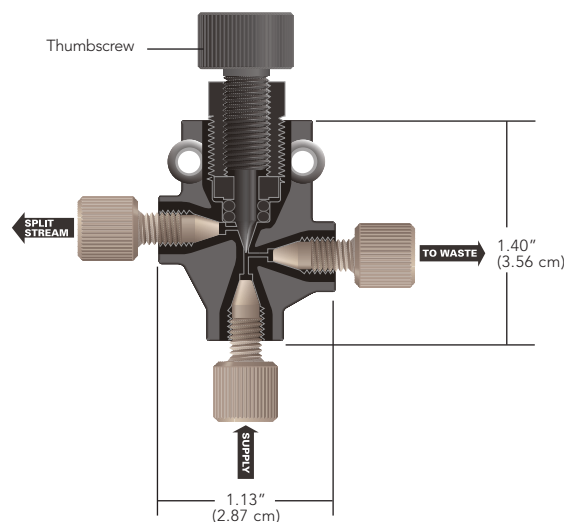

P-450
Standard Micro-Splitter Valve



SPECIFICATIONS & DETAILS

Part No.	Valve Type	Threads	Internal Volume ¹ (closed/fully open)	Max. Operating Pressure
P-450	Standard	1/4-28	2.1 / 4.1 μ L	800 psi (55 bar)
P-451 Obsolete	Standard	10-32	1.2 / 2.8 μ L	800 psi (55 bar)
P-460S, T Obsolete	High Pressure	10-32	1.2 / 2.8 μ L	4,000 psi (276 bar)
P-470	High Pres. Graduated	10-32	1.2 / 2.8 μ L	4,000 psi (276 bar)

¹ The supply and waste port thru-holes have IDs of 0.020" (0.50 mm). The ID for the split-stream port thru-hole is 0.020" (0.50 mm) in standard versions; in capillary versions it is 0.010" (0.25 mm).

Part No.	Description	Includes	Qty.
MICRO-SPLITTER VALVES			
P-450	Standard, 1/4-28, Biocompatible	(3) XP-235	ea.
P-451 Obsolete	Standard, 10-32, Biocompatible	(3) F-120	ea.
P-460S Obsolete	High Pressure, 10-32, with Stainless Steel Needle	(3) F-120	ea.
P-460T Obsolete	High Pressure, 10-32, with Titanium Needle	(3) F-120	ea.
GRADUATED MICRO-SPLITTER VALVES			
P-470	High Pressure Graduated, 10-32, with Stainless Steel Needle	(3) F-120	ea.

* Use with the MicroTight Tubing Sleeves, found on page 52.



Micro-Metering Valves

- › Flow rates as low as 3.5 $\mu\text{L}/\text{min}^*$
- › 1/4-28 flat-bottom and 10-32 coned designs available
- › **Materials of construction:** PEEK, PTFE

* At 1.0 mL/min incoming flow rate with room temperature water.

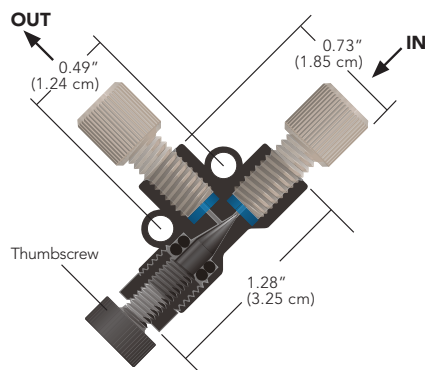

P-445
1/4-28 threaded
PEEK Micro-Metering Valve

For fine control of fluid flow rates, Micro-Metering Valves can reduce outgoing flow to as low as 3.5 $\mu\text{L}/\text{min}^*$. These needle valves are perfect for use with peristaltic pump fluid-transfer applications, mass spectrometry, and fraction collection.

Our Micro-Metering Valves can also be used to regulate gas flow in helium sparging lines and as a flow-dependent variable back pressure regulator. For flow independent regulation of back pressure, please see page 147.

Flow path materials are PEEK polymer and PTFE. All versions of this valve have 0.020" (0.50 mm) thru-holes.



APPLICATION NOTE

Back Pressure Considerations

The Micro-Splitter Valves are designed to work when both effluent flow path pressures are nearly identical. However, the split flow path will often have higher back pressure than the waste flow path, making it hard to achieve any split flow at all. There are two possible solutions. Place a back pressure regulator (page 143) on the waste flow path that is equal to or slightly greater than the pressure on the split flow path.

Or, switch the two effluent pathways such that the split flow pathway is attached to the "waste" port on the valve and the waste flow pathway is attached to the "split" port on the valve. (*Please Note: This second method may result in a loss of adjustment sensitivity.*)

Multi-Column and Detector Systems

Does your work require analyses with multiple columns and detectors that use the same mobile phase? If so, install one of our High Pressure Micro-Splitter Valves after your injector. A single injection can then be split to two separate columns and detector systems, at two different flow rates.

This economical set-up eliminates the need for an additional pump and injector valve, while allowing data to be obtained simultaneously.

Post-Detector Interfacing

Use a Standard Micro-Splitter Valve to route fluid exiting an initial detector to other devices, such as a mass spectrometer and a fraction collector. The valve will split and reduce the flow rate to that required for MS interfacing, while diverting the remainder of the flow to the collector (a back pressure regulator may also be required for this set up, available on page 143).

Other Applications

These valves are also suited for other applications, such as adapting a standard HPLC system to handle microbore analyses. For more information and plumbing diagrams for this application and those listed above, please contact your local distributor or IDEX Health & Science directly.

Part No.	Material	OD Tubing	Thru-hole	Internal Volume*	Includes	Qty.
MICRO-METERING VALVES						
P-445	PEEK, Black	1/16"	0.020" (0.50 mm)	7.7 μL	(2) XP-230	ea.
P-446	PEEK, Black	1/16"	0.020" (0.50 mm)	7.2 μL	(2) F-120	ea.
P-447	PEEK, Black	1/8"	0.020" (0.50 mm)	7.7 μL	(2) XP-330	ea.

* Maximum internal volume, with valve fully open.

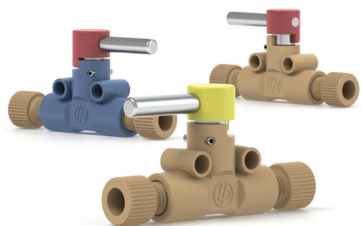

Shut-Off Valves

- › Biocompatible, all-polymer flow path
- › Available for 1/16" and 1/8" OD tubing
- › Pressure rated to 500 psi (34 bar)

Stop a flow stream quickly with IDEX Health & Science biocompatible Shut-Off Valves. The bodies are manufactured from ETFE, and a PEEK rotor, making them highly resistant to chemical attack. The blue colorant used in some valve configurations has proven not to leach out with common HPLC solvents.

Connect semi-rigid or rigid tubing, such as PEEK, stainless steel or fluoropolymer, with the 1/4-28 Flangeless Fittings provided. Soft tubing, such as PharMed® or Tygon® (see page 14), may be connected to these valves using our 1/4-28 barbed adapters, found on page 90.

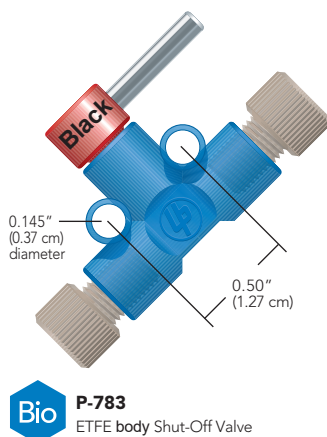

Part No.	Material	OD Tubing	Thru-hole	Internal Volume*	Includes	Qty.
SHUT-OFF VALVES, BIOCOMPATIBLE						
P-721	ETFE body, PEEK rotor black	1/8"	0.040" (1.0 mm)	10.0 µL	(2) P-335, (2) P-300N	ea.
P-732 Obsolete	PEEK, Natural	1/16"	0.020" (0.5 mm)	2.5 µL	(2) XP-235	ea.
P-733 Obsolete	PEEK, Natural	1/8"	0.040" (1.0 mm)	10.0 µL	(2) XP-335	ea.
P-782	ETFE body, PEEK rotor black	1/16"	0.020" (0.5 mm)	2.5 µL	(2) XP-235	ea.
P-783	ETFE body, PEEK rotor black	1/8"	0.040" (1.0 mm)	10.0 µL	(2) XP-335	ea.

* Maximum internal volume, with valve fully open.



BACK PRESSURE REGULATORS

Back Pressure Regulators (BPR) are designed to enhance system performance through outgassing prevention and improved pump check valve efficiency. It includes 5 and 20psi assemblies (replacement cartridges not available), a variety of pressure rated cartridges and assemblies, PEEK and stainless steel BPR holders, high pressure adjustable BPR for pressure between 2000 and 5000psi and ultra-low volume BPRs set to 100 and 500psi.

- 144** ULTRA-LOW VOLUME BACK PRESSURE REGULATOR
- 145** BACK PRESSURE REGULATOR ASSEMBLIES
- 146** BACK PRESSURE REGULATOR HOLDERS
- 147** BACK PRESSURE REGULATOR CARTRIDGES
- 148** PRESSURE RELIEF VALVES



Ultra-Low Volume Back Pressure Regulators (BPRs)

- Wetted flow path materials: PEEK, perfluoroelastomer, and ETFE
- Available pressure settings of 100 or 500 psi (7 or 34 bar)
- Low swept volume of only 6 μL

Our Ultra-Low Volume Back Pressure Regulators (BPRs) were developed to minimize swept volume, which is especially important for multi-detector applications. With a maximum swept volume of only 6 μL *, it is nearly impossible to detect these BPRs as part of your fluid pathway. To minimize the swept volume added to your flow path, we recommend trimming the length of the attached tubing. And because the flow path is completely polymeric, you are assured of biocompatibility.

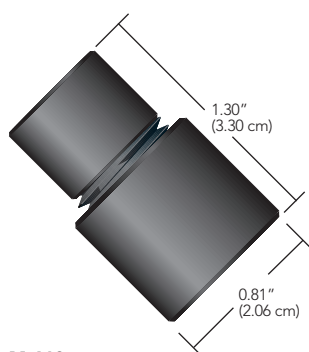

M-410
MicroVolume BPR Assembly
Attached tubing not shown

Please Note: Our Ultra-Low Volume Back Pressure Regulators cannot be used as check valves due to their unique internal design. Try our Micro-Volume Inline Check Valve on page 137.

** The maximum internal swept volume listed above is for the back pressure regulator only and does not include the volume of the attached tubing lines.*



SPECIFICATIONS & DETAILS

	Back Pressure Setting psi (bar)	Flow Rate Recommendations	Recommended Pressure Range psi (bar)	1/16" OD Tubing
M-410	100 ² (7) ²	Optimal: 100 μL –1 mL/min Max.: 4 mL/min	40–150 (3–10)	PEEK, 0.010" ID
M-412	500 ² (34) ²	Optimal: 100 μL –1 mL/min Max.: 4 mL/min	250–525 (17–36)	PEEK, 0.010" ID
M-420	100 ³ (7) ³	Optimal: 3–8 mL/min Max.: 10 mL/min	40–150 (3–10)	PEEK, 0.020" ID

¹ All data generated using water at room temperature.

² Set at a flow rate of 0.5 mL/min.

³ Set at a flow rate of 5 mL/min.

Part No.	Description	Pressure Setting	Tubing OD	Includes	Swept Volume	Qty.
ULTRA-LOW VOLUME BPRs						
M-410	Low Flow	100 psi (7 bar)	1/16"	XP-230	6 μL	ea.
M-412	Low Flow	500 psi (34 bar)	1/16"	XP-230	6 μL	ea.
M-420	High Flow	100 psi (7 bar)	1/16"	XP-230	6 μL	ea.

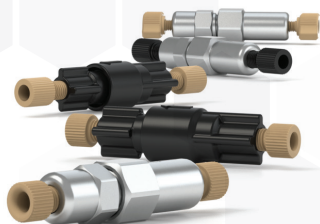

Back Pressure Regulator Assemblies

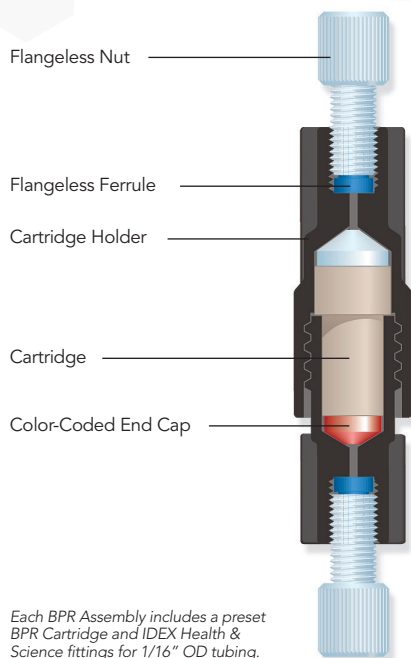

Each BPR Assembly includes a preset BPR Cartridge and IDEX Health & Science fittings for 1/16" OD tubing.

Choose from our line of Biocompatible and Stainless Steel BPR Assemblies, each complete with a replaceable, factory preset cartridge (except the 5 and 20 psi versions).

Our BPR Assemblies create incremental back pressures ranging from 5 to 1,000 psi (0.3 to 69 bar). The Biocompatible BPR Assemblies feature a PEEK holder; polymer-based fittings; biocompatible BPR cartridges and wrenches for tightening. Stainless Steel BPR Assemblies feature the same biocompatible BPR cartridges with a 316 stainless steel holder and polymer fittings.

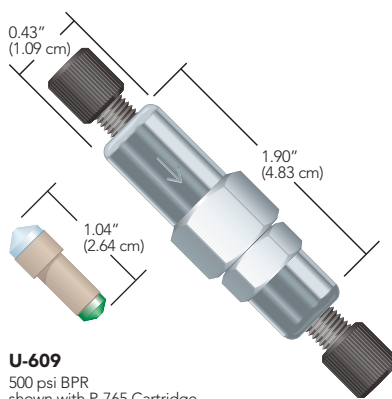

U-609
500 psi BPR
shown with P-765 Cartridge

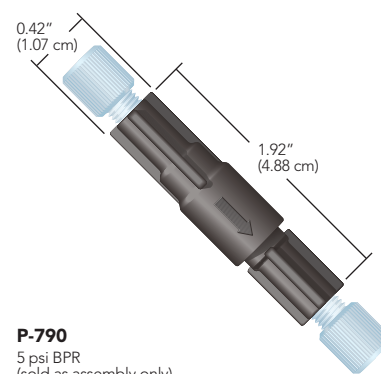

P-790
5 psi BPR
(sold as assembly only)

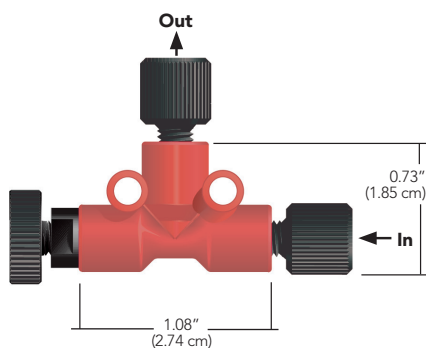

P-880
High Pressure Adjustable BPR
Includes One-Piece Fingertight Fittings for 1/16" OD tubing

High Pressure Adjustable Back Pressure Regulator

› Materials of construction: PEEK, perfluoroelastomer, and PTFE

The biocompatible P-880 High Pressure Adjustable BPR offers the flexibility to adjust your system back pressure between 2,000 and 5,000 psi (138 and 345 bar), independent of the flow. Only 10% fluctuation in pressure generally occurs with flow rates of 0.1–10 mL/min. Lower or higher flow rates will lead to greater fluctuations in pressure. To achieve the desired back pressure setting, simply turn the thumbscrew while monitoring your system pressure. Because this product creates such high back pressure, please check system component specifications prior to using to avoid damaging any sensitive components.

Part No.	Pressure Setting	Holder Material	Includes	Swept Volume	Qty.
BPR ASSEMBLIES					
P-790	5 psi (0.3 bar)	PEEK	(2) XP-215	134 µL	ea.
P-791	20 psi (1.4 bar)	PEEK	(2) XP-215	134 µL	ea.
P-785	40 psi (2.8 bar)	PEEK	(1) P-761, (2) XP-215	131 µL	ea.
P-786	75 psi (5.2 bar)	PEEK	(1) P-762, (2) XP-215	131 µL	ea.
P-787	100 psi (7 bar)	PEEK	(1) P-763, (2) XP-215	131 µL	ea.
P-788	250 psi (17 bar)	PEEK	(1) P-764, (2) XP-235	102 µL	ea.
P-789	500 psi (34 bar)	PEEK	(1) P-765, (2) P-250, (2) LT-115	96 µL	ea.
P-455	1,000 psi (69 bar)	PEEK	(1) P-796, (2) P-250, (2) LT-115	89 µL	ea.
U-605	40 psi (2.8 bar)	SST	(1) P-761, (2) XP-201	129 µL	ea.
U-606	75 psi (5.2 bar)	SST	(1) P-762, (2) XP-201	129 µL	ea.
U-607	100 psi (7 bar)	SST	(1) P-763, (2) XP-201	129 µL	ea.
U-608	250 psi (17 bar)	SST	(1) P-764, (2) XP-201	99 µL	ea.
U-609	500 psi (34 bar)	SST	(1) P-765, (2) XP-201	93 µL	ea.
U-610	750 psi (52 bar)	SST	(1) P-795, (2) P-250, (2) LT-115	91 µL	ea.
HIGH PRESSURE ADJUSTABLE BPR ASSEMBLY					
P-880	2,000–5,000 psi (138–345 bar)		(2) F-120BLK	9 µL	ea.

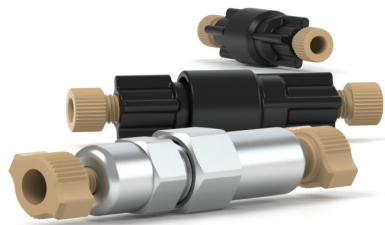

Back Pressure Regulator Holders

P-465 PEEK and U-469 Stainless Steel BPR Holders work with any of our replacement BPR Cartridges. Each holder comes with fittings for 1/16" OD tubing (see below). The U-469 Holder is surface-treated to prevent galling, a potential problem with large, threaded metal parts.

Please Note: These Back Pressure Regulator Holders are designed to allow each cartridge to operate at its stated pressure setting when tightened to 20 in-lbs. of torque. To approximate this level of torque, first finger tighten the Holder, then tighten an additional 1/8–1/4 turn with the supplied wrenches.

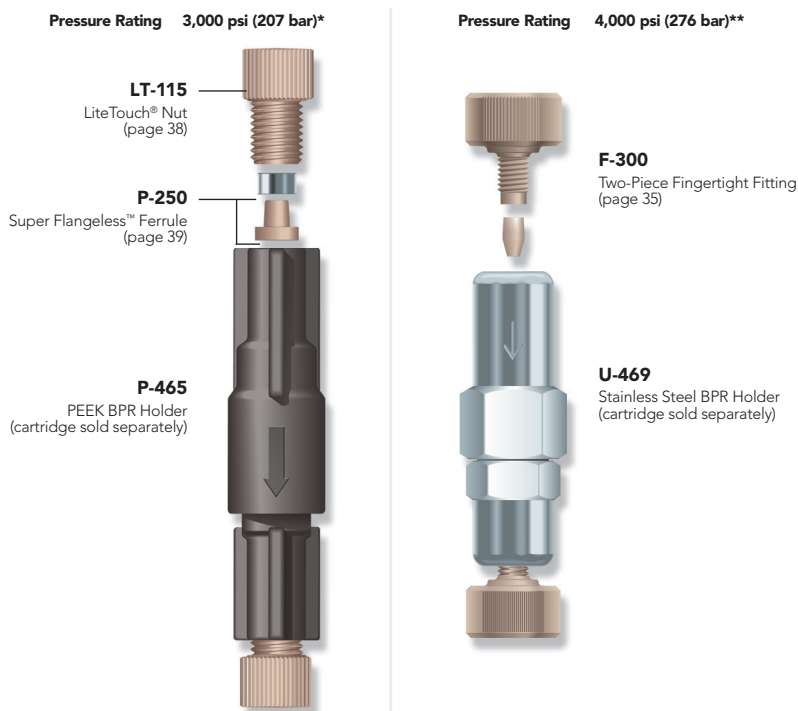

* Using PEEK tubing and supplied fittings.

** Using stainless steel tubing and supplied fittings.

Part No.	Pressure Setting	Holder Material	Includes	Swept Volume	Qty.
BPR HOLDERS					
P-465	Biocompatible BPR	PEEK	(2) P-250, (2) LT-115	7 µL	ea.
U-469	High Pressure BPR	SST	(2) F-300	4 µL	ea.



Back Pressure Regulator Cartridges



APPLICATION NOTE

Small gas bubbles often form as solvent moves from the high pressure of an HPLC column to the low pressure environment leading to the detector. This outgassing can cause erratic baseline readings and loss of sensitivity. Placing a BPR (usually a 40–100 psi) after the detector provides an excellent, low-cost method for reducing this problem by maintaining enough back pressure on the mobile phase to keep gases dissolved in solution.

A back pressure regulator can also be used as a pump preload for low and fluctuating pressure applications. Many of today's pumps require a steady back pressure to function properly. Install an IDEX Health & Science BPR (usually 500–1,000 psi) between the pump and the injector to enhance pump performance.

Caution: Do not exceed the maximum operating pressure of your system — please refer to the operating manuals for your system components before choosing the appropriate BPR.

- › Proven outgassing protection
- › Flow-independent pump preload for greater pump efficiency
- › 5 to 1,000 psi cartridges and assemblies available

Back Pressure Regulators are designed to enhance system performance through outgassing prevention and improved pump check valve efficiency.

IDEX Health & Science back pressure regulators include:

- › 5 and 20 psi assemblies (replacement cartridges not available)
- › 40, 75, 100, 250, 500, 750, and 1,000 psi cartridges and assemblies
- › PEEK and stainless steel BPR holders
- › High pressure adjustable BPR for pressures between 2,000 and 5,000 psi
- › Ultra low volume BPRs set to 100 and 500 psi (page 144)

For flow control options try the Micro-Metering Valves found on page 141.

Back Pressure Regulator Replacement Cartridges

- › Materials of construction: PEEK, ETFE, perfluoroelastomer, and gold-plated stainless steel

These replacement cartridges will operate in any of the standard BPR holders shown on this page. These cartridges create back pressures from 40 to 1,000 psi (2.8 to 69 bar)—all independent of flow except as noted below.

The recommended operating flow rate range for our BPR Cartridges is 0.1 mL–10 mL/min. Within this range, the amount of back pressure created by the BPR Cartridges and Assemblies will not vary more than $\pm 10\%$. Lower or higher flow rates may result in larger pressure fluctuations.



P-761
40 psi BPR Cartridge

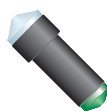

P-796
1,000 psi BPR Cartridge

COLOR CODING

Part No.	Pressure Setting	COLOR CODING		Swept Volume	Qty.
		Body	End-Cap		
BPR CARTRIDGES					
P-761	40 psi (2.8 bar)	Tan	Blue	125 μ L	ea.
P-762	75 psi (5.2 bar)	Tan	Yellow	125 μ L	ea.
P-763	100 psi (7 bar)	Tan	Red	125 μ L	ea.
P-764	250 psi (17 bar)	Tan	White	95 μ L	ea.
P-765	500 psi (34 bar)	Tan	Green	89 μ L	ea.
P-795	750 psi (52 bar)	Black	Blue	87 μ L	ea.
P-796	1,000 psi (69 bar)	Black	Green	83 μ L	ea.



Pressure Relief Valves

› Prevent system over-pressurization

Our Pressure Relief Valves are ideal for preventing system over-pressurization. These products protect system components by diverting fluid flow automatically when inline pressure exceeds the set limit. Choose between preset 100 psi (7 bar) and 5 psi (0.3 bar) assemblies, both shipped with Flangeless Fittings. The 100 psi version is a good, general purpose valve, while the 5 psi version is perfect for protecting syringe and peristaltic pump systems. The void volume of both relief valves is low due to the small 0.020" (0.50 mm) thru-holes in the valve tee body.

If you wish to have the Pressure Relief Valve open at a different pressure than 5 or 100 psi, simply combine one of the other replacement Back Pressure Regulator Assemblies listed on page 145 with the P-612 Pressure Relief Valve Tee. Choose the P-612S for larger bore tubing and higher flow applications.

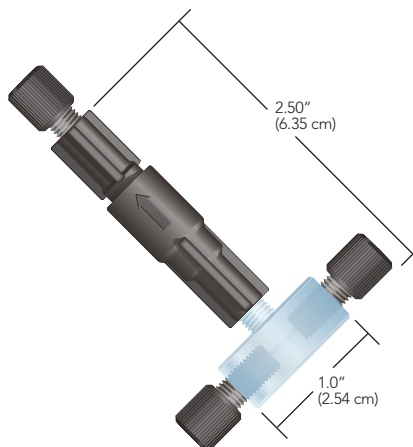

U-455

Pressure Relief Valve
Includes Flangeless Fittings
for 1/16" OD tubing
(Drawing is not actual size)

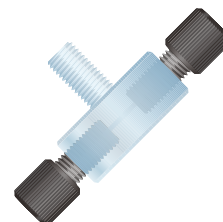

P-612

Pressure Relief Valve Tee
Includes Flangeless Fittings
for 1/16" OD tubing
(Drawing is not actual size)

Part No.	Description	Pressure Setting	Tubing OD	Includes	Swept Volume	Qty.
PRESSURE RELIEF VALVES						
U-455	Pressure Relief Assembly	5 psi (0.3 bar)	1/16"	XP-201	148 µL	ea.
U-456	Pressure Relief Assembly	100 psi (7 bar)	1/16"	XP-201, wrenches	139 µL	ea.
P-612	Pressure Relief Tee Only	1/16"	1/16"	XP-201	14 µL	ea.
P-612S Obsolete	Pressure Relief Tee Only	3/16"	3/16"	XP-201	348 µL	ea.